



The Catalog





Office & archive

At C + P, you'll find the right cabinet for every application. Choose from a wide selection of cabinet types ranging from hinged-door, sliding-door and tambour cabinets to glass door cabinets and cabinets with drawers, for filing or for a multi-drawer cabinet.

With a variety of practical interior fittings, your C + P cabinet can be individually designed for new storage and organization needs at any time.

Add to this a competent range of lounge furniture, tables, chairs, storage space near the workstation, caddies and accessories for contemporary office furniture.

Cabinet and filing systems



356

Hinged-door cabinets
Acurado | Asisto | Certos (flame-resistant)



386

Sliding-door cabinets
Acurado | Asisto

Office furniture & accessories



440

Counters and lounge furniture



446

Tables



400

Tambour cabinets
Omnispace | Asisto



414

Drawer and filing cabinets
Acurado | Asisto | 7000 series



454

Around the desk



460

Chairs and stools



470

Cabinets, pedestals and caddies



Hinged-door cabinets

Sturdy and long-lasting.



Acurado series

The favorably priced cabinets for classic filing

- + Sturdy steel construction with high-quality enamel coating
- + With sliders for floor protection as standard
- + Shelves, coated light gray
- + Ergo-Lock grip lock (3-bolt) with 2 keys and optional exchangeable cylinder
- + Doors on bolt hinges, door opening angle of approx. 110°
- + Complete product line (different dimension variants and interior fittings for every requirement)

Asisto series

The attractive steel cabinets and shelving for any office

- + Sturdy steel construction with high-quality enamel coating
- + Appealing design thanks to narrow edges
- + Sliders for floor protection, as standard with level adjustment, adjustable from inside
- + Metal cabinet handles, matt nickel-plated
- + Shelves, coated black gray
- + 3-bolt safety lock with exchangeable cylinder, 2 keys
- + Hinged doors with approx. 225° door opening angle
- + Doors with wood decor fronts as standard, also available in steel or as glass doors
- + Complete product line (different dimension variants and interior fittings for every requirement)



Certos series (flame-resistant)

The double-walled cabinets with protection against fires and attempted burglary

- + Double-walled, sturdy steel construction with special insulating plates between the walls and high-quality enamel coating
- + Protection against minor fires and attempted burglary
- + Increased protection against burglary thanks to burglar-proof door design on the side and sturdy door locks
- + With sliders for floor protection as standard
- + Shelves, coated light gray
- + Double-bit safety lock with five-bolt bolt lock system, with 2 keys
- + Doors on external sturdy bolt hinges, convenient door opening angle of approx. 180°
- + Optional electronic code lock
- + Complete product line (various heights and dimension variants for every requirement)



Sliding-door cabinets → p. 386



Tambour cabinets → p. 400

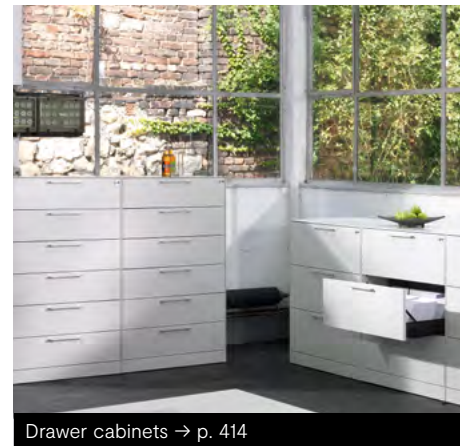

Drawer cabinets → p. 414

The patented Ergo-Lock from C+P



Outstanding operating safety, wear resistance and an attractive appearance characterize the patented “Ergo-Lock” grip lock from C+P. The **“simply push shut to close”** feature in particular already makes the work of hundreds of thousands of users easier—and soon yours, too!

Features of the Ergo-Lock:

- + **High-quality appearance—current and contemporary**
Fits in with any room and gives your cabinet a distinctive look.
- + **Patented “simply push shut to close” mechanism**
Neatly close a cabinet, even if your hands are full—only from C+P.
- + **Exchangeable cylinder, subsequent replacement, simultaneous locking—it’s all possible!**
Remain open to future change and safeguard the security of your investment.
- + **Suitable locking systems with PIN code or transponder with the same appearance.**
Use a PIN code or transponder instead of a key with the same design if required for security purposes. As a complete, electronic offline lock, the Ergo-Lock offers full state-of-the-art features.

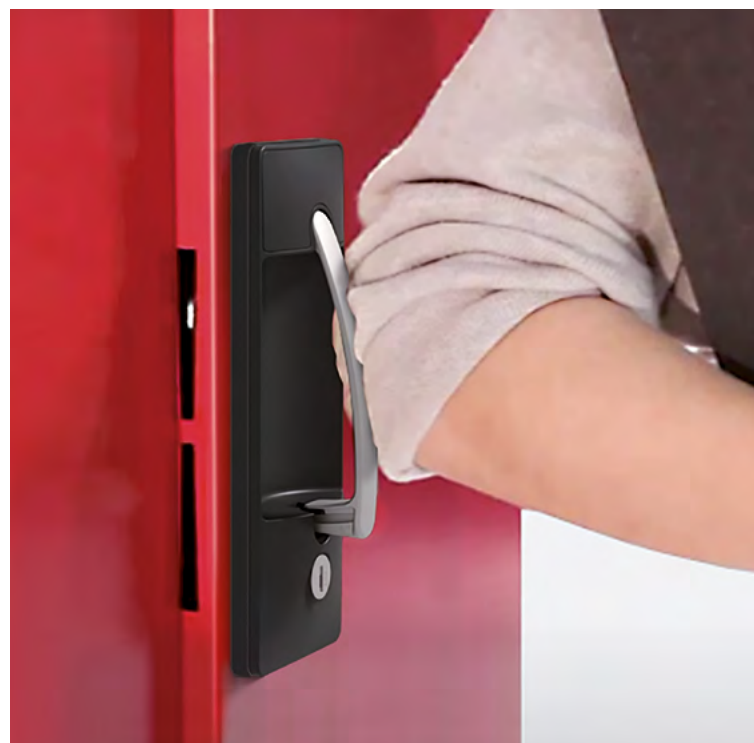

Whether you use it as a key lock or with PIN codes or transponders, the Ergo-Lock product range offers the right system to suit every requirement.



Opt for security and access control to suit your particular needs:



Mechanical locking system

- + 2 keys per lock
- + Standard design for all Acurado hinged-door cabinets
- + Also easy and convenient to operate with gloves



PIN code lock

- + Motorized locking bolt
- + 4 digits
- + 4- to 8-digit codes possible
- + Optical function feedback (green/red)
- + Master key code
- + Usage range: +5 to +40°C
- + Operated with 2 standard AA batteries (alkaline)
- + Batteries last for approx. 30,000 openings or approx. 3 years

Order no.	8900-750
Price	225,-



RFID transponder lock

- + Motorized locking bolt
- + Transponder type: MIFARE® DESFire®
- + Can be integrated into existing access control systems
- + USB programming interface
- + Optical function feedback (green/red)
- + Easy operation with programmable user and master cards, as well as a service card
- + Management software also available as an option
- + Usage range: +5 to +40°C
- + Operated with 2 standard AA batteries (alkaline)
- + Batteries last for approx. 30,000 openings or approx. 3 years

Order no.	8900-740
Price	On request

Acurado

Hinged-door cabinets.

Features of the hinged-door cabinets:

- + Sturdy steel construction with high-quality enamel coating
- + Wide range of different dimensions for any application
- + With sliders for floor protection as standard
- + Shelves, coated light gray
- + Improved operating safety, wear resistance and an attractive ergonomic appearance thanks to the Ergo-Lock grip lock (3-bolt latch) in black with 2 keys
- + Doors on bolt hinges, door opening angle of approx. 110°
- + Door reinforcement for high stability
- + Highly flexible interior fitting options thanks to adjustability in 15 mm steps
- + Interesting range of counter and top solutions as well as shelving
- + High load capacity of 70 kg per shelf, reinforced shelf can bear loads up to 110 kg, for reinforcement see page 365



Order no. 9260-000



- + **Ergo-Lock grip lock**
Improved operating safety, wear resistance and an attractive appearance thanks to the grip lock (3-bolt latch) in black with 2 keys—the door can be closed simply by squeezing the grip lock

To Ergo-Lock → p. 358

Dimensions and version

With **Ergo-Lock triple-bolt grip lock**



Height: 1,950	Width	500	500	700	700
	Depth	400	500	400	500
	Interior dimensions, H x W x D	1840 x 498 x 353	1840 x 498 x 453	1840 x 698 x 353	1840 x 698 x 453
	Shelves	4	4	4	4
	Order no.	9234-000	9235-000	9236-000	9237-000
	Price	436,-	501,-	490,-	563,-

- + **Additional shelves**
Coated steel, light gray, in special color (project specific) on request

	Width x depth	497 x 352	497 x 452	697 x 352	697 x 452
	& order no.	+ 1034-80	+ 1035-80	+ 1036-80	+ 1037-80
	& unit price	+ 25,-	+ 27,-	+ 29,50	+ 31,50

- + **Underframes made of square tube, 150 mm high, adjustable level**
Black gray RAL 7021, other colors on request

	Width x depth	-	-	-	-
	& order no.	-	-	-	-
	& unit price	-	-	-	-

- **Body and door color**

Color concept → p. 48

- + **Reinforced shelf**

Selection → p. 372



Company

Color concept

Changing room & wardrobe

Workshop & factory

Office & archive

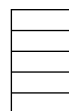
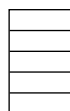
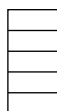
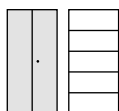

930
400
1840x928x353
4
9260-000
544,-

930
500
1840x928x453
4
9280-000
626,-

930
600
1840x928x553
4
9290-000
735,-

1200
400
1840x1198x353
4
9460-000
680,-

1200
500
1840x1198x453
4
9480-000
782,-

1200
600
1840x1198x553
4
9490-000
918,-

925x352
+ 1040-80
+ 34,-

925x452
+ 1050-80
+ 36,50

925x552
+ 1051-80
+ 38,50

1195x352
+ 9360-80
+ 43,-

1195x452
+ 1060-80
+ 46,-

1195x552
+ 1061-80
+ 48,50

930x400
+ 9964-000
+ 129,-

930x500
+ 9984-000
+ 142,-

930x600
+ 9994-000
+ 155,-

1200x400
+ 2027-000
+ 158,-

1200x500
+ 2028-000
+ 173,-

1200x600
+ 2033-000
+ 189,-

+ Accessories

Hanging frames, binder supports and locks → p. 372

Acurado

Office bookcases.



Order no. 9160-000

Dimensions and version

Office bookcases are cabinets without doors and with shelves



Height: 1,950	Width	500	500	700	700
	Depth	400	500	400	500
	Interior dimensions, H x W x D	1840 x 498 x 353	1840 x 498 x 453	1840 x 698 x 353	1840 x 698 x 453
	Shelves	4	4	4	4
	Order no.	9134-000	9135-000	9136-000	9137-000
	Price	349,-	401,-	392,-	451,-

+ Additional shelves
Coated steel

	Width x depth	497 x 352	497 x 452	697 x 352	697 x 452
	& order no.	+ 1034-80	+ 1035-80	+ 1036-80	+ 1037-80
	& unit price	+ 25,-	+ 27,-	+ 29,50	+ 31,50

+ Underframes made of square tube, 150 mm high, adjustable level
Black gray RAL 7021, other colors on request

	Width x depth	-	-	-	-
	& order no.	-	-	-	-
	& unit price	-	-	-	-

→ Body color

Color concept → p. 48

+ Reinforced shelf

Selection → p. 372



Company

Color concept

Changing room & wardrobe

Workshop & factory

Office & archive

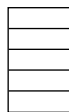
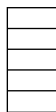

930
400
1840 x 928 x 353
4
9160-000
436,-

930
500
1840 x 928 x 453
4
9180-000
501,-

930
600
1840 x 928 x 553
4
9190-000
588,-

1200
400
1840 x 1198 x 353
4
9360-000
544,-

1200
500
1840 x 1198 x 453
4
9380-000
626,-

925 x 352
+ 1040-80
+ 34,-

925 x 452
+ 1050-80
+ 36,50

925 x 552
+ 1051-80
+ 38,50

1195 x 352
+ 9360-80
+ 43,-

1195 x 452
+ 1060-80
+ 46,-

930 x 400
+ 9964-00
+ 129,-

930 x 500
+ 9984-00
+ 142,-

930 x 600
+ 9994-00
+ 155,-

1200 x 400
+ 2027-00
+ 158,-

1200 x 500
+ 2028-00
+ 173,-

+ Accessories

Hanging frames, binder supports and locks → p. 372



+ More file shelving

Selection → p. 372

! All dimensions in mm, and all prices in Euros

Acurado

Hinged-door cabinets.



Order no. 9260-100

Dimensions and version

With different interior fittings

With **Ergo-Lock** triple-bolt grip lock

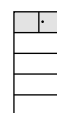
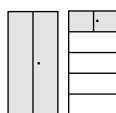

Height: 1,950	Depth	400	500
Width: 930	Interior dimensions, HxWxD	1840 x 928 x 353	1840 x 928 x 453
	Shelves	3	3
	Two-door security compartment, HxWxD	1 335 x 755 x 335	1 335 x 755 x 435
	Description	Security compartment with cylinder lock	Security compartment with cylinder lock
	Order no.	9260-100	9280-100
	Price	746,-	827,-

⊕ **Additional shelves**
Coated steel (standard)

 <p>Steel shelves</p>	Width x depth	925 x 352	925 x 452
	& order no.	+ 1040-80	+ 1050-80
	& unit price	+ 34,-	+ 36,50

→ **Body and door color**

Color concept → p. 48



Order no. 9280-30



Order no. 9280-088

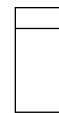
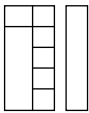

400
1840 x 375 x 350
4
-
Storage shelf with extendable coat rack rail (without coat hangers) on the left, coat rack section: approx. 550 mm wide
9260-30
675,-

500
1840 x 459 x 450
4
-
Storage shelf with coat rack rail (without coat hangers) on left, central partition
9280-30
757,-

500
1840 x 928 x 453
-
-
Full-length storage shelf on the inside with coat rack rail (without coat hangers)
9280-088
606,-

375 x 349 (additional shelf for right side for 9260-30)
+ 1040-38
+ 21,50

459 x 449 (additional shelf for right side for 9280-30)
+ 1050-38
+ 25,50

+ Reinforced shelf

Load capacity per shelf	110 kg
& order no.	+ ...-802
Price	Double the shelf price

+ Accessories

Hanging frames, binder supports and locks → p. 372

Acurado

Office cabinets and bookcases.



Order no. 9260-410



Order no. 9160-600

Dimensions and version

Office cabinets with suspension bars and compartments with Ergo-Lock triple-bolt grip lock

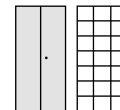
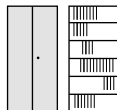

Height: 1,950	Depth	400	400
Width: 930	Description Dimensions, HxWxD	6 suspension bars (for Elba/Leitz)	21 compartments 240 x 280 x 352
	Interior dimensions, HxWxD	1840 x 928 x 353	1840 x 928 x 353
	Order no.	9260-600	9260-410
	Price	685,-	847,-

→ Body and door color

Color concept → p. 48



Dimensions and version

Office bookcases with suspension bars and compartments
Office bookcases are cabinets without doors with rear panel and shelves in light gray

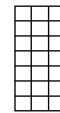

Height: 1,950	Depth	400	400
Width: 930	Description	6 suspension bars	21 compartments
	Interior dimensions, HxWxD	1840 x 928 x 353	1840 x 928 x 353
	Order no.	9160-600	9160-410
	Price	577,-	739,-

+ Additional shelves

Selection → p. 372

+ Accessories

Selection → p. 372

Acurado

Top cabinets and bookcases.



Order no. 9264-000/9464-00

Dimensions and version

Top cabinets with Ergo-Lock
triple-bolt grip lock, incl. accessories for mounting to underbench cabinet



Height	500	500	500	500	500	500
Width	930	930	930	1200	1200	1200
Depth	400	500	600	400	500	600
Shelves	-	-	-	-	-	-
Binder heights	1	1	1	1	1	1
Interior dimensions, HxWxD	440x928x353	440x928x453	440x928x553	440x1198x353	440x1198x453	440x1198x553
Order no.	9264-000	9284-000	9294-000	9464-000	9484-000	9494-000
Price	323,-	371,-	436,-	403,-	464,-	544,-

+ Top cabinets, simultaneous locking

& order no.	+ 8900-7211
& addtl. charge	+ 25,-

Dimensions and version

Top bookcases incl. accessories for mounting to underbench cabinet



Height	500	500	500	500
Width	930	930	1200	1200
Depth	400	500	400	500
Shelves	-	-	-	-
Binder heights	1	1	1	1
Interior dimensions, HxWxD	440x928x353	440x928x453	440x1198x353	440x1198x453
Order no.	9164-000	9184-000	9364-000	9384-000
Price	258,-	297,-	323,-	371,-

→ Customer must provide wall mounting for top cabinets and bookcases

→ **Body and door color**

Color concept → p. 48

+ Accessories

Binder supports and locks → p. 372



Order no. 9165-000



790	790	790	790	790	790
930	930	930	1200	1200	1200
400	500	600	400	500	600
1	1	1	1	1	1
2	2	2	2	2	2
730 x 928 x 353	730 x 928 x 453	730 x 928 x 553	730 x 1198 x 353	730 x 1198 x 453	730 x 1198 x 553
9265-000	9285-000	9295-000	9465-000	9485-000	9495-000
403,-	464,-	544,-	504,-	580,-	680,-

+ 8900-7211

+ 25,-



790	790	790	790
930	930	1200	1200
400	500	400	500
1	1	1	1
2	2	2	2
730 x 928 x 353	730 x 928 x 453	730 x 1198 x 353	730 x 1198 x 453
9165-000	9185-000	9365-000	9385-000
323,-	371,-	403,-	464,-

+ Additional shelves

Coated steel (standard), only possible with cabinet/bookcase height of 790 mm

<p>Steel shelves</p>	For cabinets (WxD)	930x400	930x500	930x600	1200x400	1200x500	1200x600
	Width x depth	925 x 352	925 x 452	925 x 552	1195 x 352	1195 x 452	1195 x 552
	& order no.	+ 1040-80	+ 1050-80	+ 1051-80	+ 9360-80	+ 1060-80	+ 1061-80
	& unit price	+ 34,-	+ 36,50	+ 38,50	+ 43,-	+ 46,-	+ 48,50

Acurado

Occasional and counter cabinets/shelving.



Order no. 9267-1200



Order no. 9286-1200
& 1125-110 (steel top cover)

Dimensions and version

Occasional and counter cabinets with MCPB top, 25 mm thick, with **Ergo-Lock** triple-bolt grip lock



Height	1000	1000	1000	1000
Width	930	930	1200	1200
Depth	400	500	400	500
Shelves	1	1	1	1
Binder heights	2	2	2	2
Interior dimensions, HxWxD	855 x 928 x 353	855 x 928 x 453	855 x 1198 x 353	855 x 1198 x 453
Order no.	9266-1200	9286-1200	9466-1200	9486-1200
Price	484,-	544,-	585,-	660,-

Occasional and counter shelving with MCPB top, 25 mm thick



Order no.	9166-1200	9186-1200	9366-1200	9386-1200
Price	403,-	452,-	484,-	544,-

+ Alternative top covers Instead of MCPB top

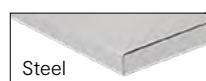

Width	930	930	1200	1200
Depth	400	500	400	500
& order no.	+ 1124-110	+ 1125-110	+ 2016-110	+ 2017-110
& addtl. charge	+ 0,-	+ 0,-	+ 0,-	+ 0,-

→ Body and door color

Color concept → p. 48

→ Top decor

Color concept → p. 52

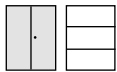

1200
930
400
2
3
1055 x 928 x 353
9267-1200
524,-



1200
930
500
2
3
1055 x 928 x 453
9287-1200
591,-



1200
1200
400
2
3
1055 x 1198 x 353
9467-1200
635,-



1200
1200
500
2
3
1055 x 1198 x 453
9487-1200
718,-



9167-1200
436,-



9187-1200
489,-



9367-1200
524,-



9167-1200
436,-

⊕ **Under frame 150 mm high,**
made of square tube,
adjustable level. Black gray
RAL 7021, other colors on
request

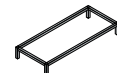
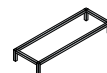

Width	930	930	1200	1200
Depth	400	500	400	500
& order no.	+ 9964-00	+ 9984-00	+ 2027-00	+ 2028-00
& price	+ 129,-	+ 142,-	+ 158,-	+ 173,-

⊕ **Additional accessories**

Binder supports and locks → p. 372

Acurado

Accessories for hinged-door cabinets.

Additional shelves

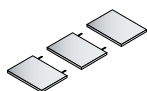

For cabinets	91/9260-410	9260-30	9280-30	Shelf support set Zinc-plated, pack. unit = 20 pc.
Cabinet dimensions, WxD	930 x 400	930 x 400	930 x 500	
	The vertical partitions of the cabinets are permanently installed. The horizontal intermediate shelves are supported on both sides and can only be adjusted vertically together. Additional shelves are supplied loose.	Filing section Shelf for right side	Filing section Shelf for right side	
	With front edging			
Order no.	1040-49	1040-38	1050-38	1118-00-20
Price	63,-	21,50	25,50	20,-

Reinforced shelf

Load capacity per shelf	110 kg
& order no.	+ ...-802
Price	Double the shelf price

Hanging frame

Fully extendable, on ball bearings, with adjustable dividers, including anti-tilt mechanism, cannot be retrofitted, color: light gray RAL 7035

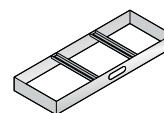
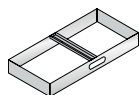

For cabinet width	930	930	1200	1200
For cabinet depth	400	500	400	500
Inner useful depth	328	328	328	328
Rows	2-row		3-row	
For files	DIN A4	DIN A4	DIN A4	DIN A4
Order no.	1040-811	1050-811	9360-811	1060-811
Price	225,-	230,-	237,-	241,-

Divider

Single, for hanging frame

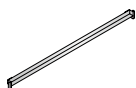

Inner useful depth	328	400
For files	DIN A4	EDP
Order no.	1000-841	1000-842
Price	15,-	15,-



Order no. 1050-811

Suspension bars

(Suspension bars from other systems on request)

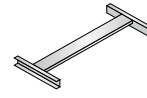
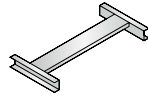

System	Elba/Leitz			Zippel		
For cabinet width	930	930	1200	930	930	1200
For cabinet depth	400	500	500	400	500	500
Inner useful width	848	848	1118	848	848	1118
Order no.	1040-82	1050-82	1060-82	1040-83	1050-83	1060-83
Price	51,-	53,-	62,-	51,-	53,-	62,-

Binder supports

Attachable, with 2-fold edging, suitable for all shelves

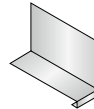

Height	100	200
Width x depth	100 x 230	100 x 270
Order no.	4221-25	4222-25
Price	25,-	28,-



Shelf with coat rack rail

Includes holder below the storage shelf (including storage shelf, possible from 500 mm exterior cabinet depth only), without coat hangers

Order no.	...-88
Price	On request



Keys and locks: Ergo-Lock



	Ergo-Lock with 2 keys	Ergo-Lock with master key system without security certificate	Master key for this	Ergo-Lock with simultaneous locking	Single/spare key	Additional charge for lock with lock no. upon request (longer delivery times)	Single/spare key for security compartment
Order no.	8900-721	8900-723	8900-7131	8900-7211	0004-11	...-...99	0006-50
Price	22,-	25,-	18,-	25,-	19,-	On request	19,-

Other additional charges

Asisto

The strength and flexibility of steel in the office.

Asisto from C + P is a leading product in all areas of modern office furniture and also offers added value that is “as strong as steel” and that you can only get from C + P. The Asisto cabinets with the innovative steel body stand out thanks to their technology, design and price-performance ratio. Asisto is the intelligent complete range from the market leader in steel furniture.

Features of Asisto hinged-door cabinets:

- + Sturdy steel construction with high-quality enamel coating
- + Appealing design thanks to narrow edges which you can only achieve with intelligently manufactured steel bodies
- + Excellent stability and suitability for moving thanks to Asisto steel body (with useful magnetic surfaces on the side)
- + Sliders for floor protection, as standard with level adjustment, adjustable from inside
- + Metal cabinet handles, matt nickel-plated
- + Shelves, coated black gray
- + 3-bolt safety lock with exchangeable cylinder, 2 keys
- + Hinged doors with approx. 225° door opening angle
- + Different fronts (steel, wood and clear glass) and tops can be matched to the steel body
- + Highly flexible interior fitting options thanks to adjustability in 15 mm steps
- + High load capacity of 70 kg per shelf
- + MCPB tops, 25 mm thick, for cabinets up to 1,635 mm in height



All units feature the narrow 6 mm edge that is characteristic for the Asisto cabinet system



The standard Asisto handles are matt nickel-plated and continue the elegant style of this product line



The adjustable hinges (opening angle of approx. 225°) are extra flat, thus allowing even better access to the cabinet interior



The Asisto level adjustment can be easily adjusted from the inside with easy access to the adjustment screw through a guide sleeve



Company

Color concept

Changing room & wardrobe

Workshop & factory

Office & archive

Asisto

Hinged-door cabinets.

Features of the hinged-door cabinets:

- + For general description, see page 374
- + Shelves made of steel in black gray RAL 7021 (standard), for additional or alternative shelves, see page 380
- + Glass doors (addtl. charge) without lock



Order no. 141032-000 & 141032-710 (steel doors)

Dimensions and door material

Hinged-door cabinets

Incl. 25 mm-thick MCPB tops
for cabinet heights up to 1,635 mm



	Width	800	1000	1200	800	1000	1200
	Depth	435	435	435	435	435	435
	Height	915	915	915	1310	1310	1310
	Interior dimensions, H x W x D	745 x 795 x 352	745 x 995 x 352	745 x 1195 x 352	1140 x 795 x 352	1140 x 995 x 352	1140 x 1195 x 352
	Shelves	1	1	1	2	2	2
	Binder heights	2	2	2	3	3	3
	Order no.	141053-000	141052-000	141051-000	141033-000	141032-000	141031-000
	Price	575,-	665,-	756,-	689,-	798,-	907,-

	Optional:						
	& order no.	+ 141053-710	+ 141052-710	+ 141051-710	+ 141033-710	+ 141032-710	+ 141031-710
	& addtl. charge	+ 75,-	+ 75,-	+ 75,-	+ 75,-	+ 75,-	+ 75,-

	Optional:						
	& order no.	+ 141053-750	+ 141052-750	+ 141051-750	+ 141033-750	+ 141032-750	+ 141031-750
	& addtl. charge	+ 228,-	+ 228,-	+ 228,-	+ 228,-	+ 228,-	+ 228,-

MCPB = Melamine coated particle board

+ Alternative top covers

Solid-core/HPL or steel → p. 380

+ Additional shelves

Selection → p. 380

+ Accessories

Binder supports and hanging frames → p. 381

→ Body and door color

Color concept → p. 48

→ Door decor (possibly top decor) or door color (with steel doors)

Color concept → p. 50

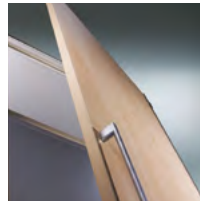

MCPB wood decor doors are standard for all Asisto cabinets (19 mm thick)



Steel doors are optional and feature double-wall insulation (19 mm thick)



Glass doors are optional and consist of safety glass (TSG) with a thickness of 6 mm

Order no. 141002-000 & 141002-710 (steel doors)

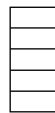
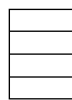
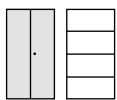

800	1000	1200	800	1000	1200
435	435	435	435	435	435
1635	1635	1635	1980	1980	1980
1465 x 795 x 352	1465 x 995 x 352	1465 x 1195 x 352	1825 x 795 x 352	1825 x 995 x 352	1825 x 1195 x 352
3	3	3	4	4	4
4	4	4	5	5	5
141013-000	141012-000	141011-000	141003-000	141002-000	141001-000
747,-	865,-	983,-	776,-	898,-	1.020,-

+ 141013-710	+ 141012-710	+ 141011-710	+ 141003-710	+ 141002-710	+ 141001-710
+ 96,-	+ 96,-	+ 96,-	+ 96,-	+ 96,-	+ 96,-

+ 141013-750	+ 141012-750	+ 141011-750	+ 141003-750	+ 141002-750	+ 141001-750
+ 326,-	+ 326,-	+ 326,-	+ 326,-	+ 326,-	+ 326,-

+ Sound absorption in the side walls
For all cabinet and shelving widths for more pleasant sound behavior of the cabinet

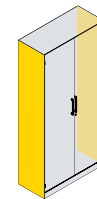
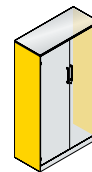
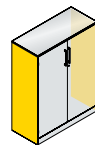
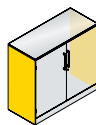

Sandwich construction (steel-absorption layer-steel)

For cabinet height	915	1310	1635	1980
Binder heights	2	3	4	5
Per cabinet/shelf & order no.	+ 141050-701	+ 141030-701	+ 141010-701	+ 141000-701
& addtl. charge	+ 83,-	+ 101,-	+ 118,-	+ 136,-

Asisto

Office bookcases.

Features of the office bookcases:

- + For general description, see p. 374
- + Shelves made of steel as standard in black gray, for additional/alternative shelves, see p. 380



Order no. 140031-000

Dimensions and version

Incl. MCPB tops, 25 mm thick, for shelving up to 1,635 mm in height



Depth: 435	Height	915	915	1310	1310	1310
	Width	800	1000	800	1000	1200
	Shelves	1	1	2	2	2
	Binder heights	2	2	3	3	3
	Interior dimensions, HxWxD	745 x 795 x 352	745 x 995 x 352	1140 x 795 x 352	1140 x 995 x 352	1140 x 1195 x 352
	Order no.	140053-000	140052-000	140033-000	140032-000	140031-000
	Price	483,-	559,-	579,-	671,-	762,-

→ Body color

Color concept → p. 48

→ Top decor

Color concept → p. 52





Company

Color concept

Changing room & wardrobe

Workshop & factory

Office & archive

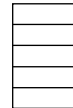
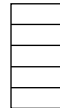
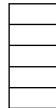
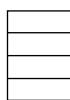
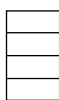

1635
800
3
4
1465 x 795 x 352
140013-000
628,-

1635
1000
3
4
1465 x 995 x 352
140012-000
727,-

1635
1200
3
4
1465 x 1195 x 352
140011-000
826,-

1980
800
4
5
1825 x 795 x 352
140003-000
652,-

1980
1000
4
5
1825 x 995 x 352
140002-000
755,-

1980
1200
4
5
1825 x 1195 x 352
140001-000
857,-

MCPB = Melamine coated particle board

+ Accessories
Tops → p. 380

+ Additional shelves
Selection → p. 380

+ Sound absorption
Selection → p. 377

Asisto

Accessories for hinged-door cabinets and office bookcases.



Steel shelves, black gray,
load capacity: 70 kg
Order no. ...-80



Glass shelves
made of 6 mm-thick safety glass (TSG),
load capacity: 40 kg
Order no. ...-580

Additional shelves

Coated steel, black gray

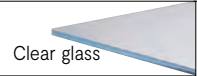

 <p>Steel</p>	For cabinet width	800	1000	1200
	Width x depth	794 x 352	994 x 352	1194 x 352
	Order no.	140003-80	140002-80	140001-80
	Unit price	32,-	34,-	43,-

Alternative design

 <p>Clear glass</p>	Thickness	6	6	6
	Order no.	140003-580	140002-580	140001-580
	Unit price	80,-	85,-	108,-

Alternative top covers

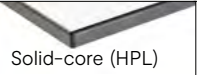
As solid-core/HPL or steel top,
instead of MCPB top

 <p>Solid-core (HPL)</p>	For cabinet width	800	1000	1200
	Depth	435	435	435
	Thickness	13	13	13
	Order no.	140003-130	140002-130	140001-130
	& addtl. charge	114,-	131,-	151,-
 <p>Steel</p>	Thickness	7	7	7
	Order no.	140003-110	140002-110	140001-110
	& addtl. charge	0,-	0,-	0,-

+ Top design

Selection → p. 52



Binder support

Attachable, for steel shelves, black gray

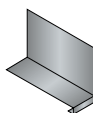

Height	200
Width	100
Depth	270
Order no.	140000-701
Price	28,-



Shelf with coat rack rail

Extendable, below the shelf, without coat hangers

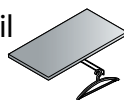

For cabinet width	800
Dimensions, HxWxD	24 x 759 x 352
Interior dimensions, WxD	759 x 363
Order no.	140003-88
Price	64,-

Hanging frame

Fully extendable, on ball bearings, with 2/4 adjustable vertical fixed links, incl. double anti-tilt mechanism, for DIN A4 files. **Cannot be retrofitted**

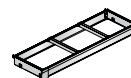
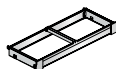

For cabinet width	800	1000	1200
Inner useful depth	330	330	330
Rows	2-row	2-row	3-row
Order no.	140003-811	140002-811	140001-811
Price	252,-	261,-	275,-

Certos

Flame-resistant cabinets.

Features of the flame-resistant Certos hinged-door cabinets:

- + **Double-walled on all sides** and especially sturdy steel construction with high-quality enamel coating
- + 25 mm-thick special insulating plates between the walls, category A1, non-flammable according to DIN 4102
- + Protection against minor fires and attempted burglary
- + Increased burglary protection thanks to burglar-proof door design on the side and sturdy door locks which snap into the side walls on the left and right
- + Wide range of different dimensions for any application
- + With sliders for floor protection as standard
- + Shelves, coated light gray
- + 5-bolt lock system (3 on the sides, 1 each at the top/bottom)
- + Double-bit safety lock with 2 keys
- + Optional electronic code lock
- + Doors on external sturdy bolt hinges, convenient door opening angle of approx. 180°
- + Highly flexible interior fitting options thanks to adjustability in 15 mm steps
- + High load capacity of 70 kg per shelf



Order no. 1161-000

Dimensions and version

Flame-resistant, incl. 25 mm-thick MCPB tops for cabinet heights up to 1,226 mm

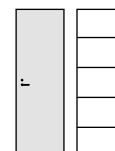
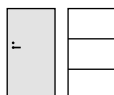

Depth: 500	Height	1226	1226	1226	1950
	Width	650	930	1200	650
	Interior dimensions, HxWxD	1060 x 598 x 429	1060 x 878 x 429	1060 x 1148 x 429	1810 x 598 x 429
	Shelves	2	2	2	4
	Weight	Approx. 64 kg	Approx. 84 kg	Approx. 102 kg	Approx. 92 kg
	Binder heights	3	3	3	5
	Security compartment dimensions, HxWxD	-	-	-	-
	Order no.	1160-000	1171-00	1181-00	1161-000
	Price	1.285,-	1.428,-	1.784,-	1.577,-

+ Additional shelves Coated steel

 Steel shelves	Width x depth	597 x 428	877 x 428	1147 x 428	597 x 428
	Order no.	+ 1160-80	+ 1170-80	+ 1180-80	+ 1160-80
	Unit price	+ 28,50	+ 33,-	+ 42,50	+ 28,50

→ Body and door color

Color concept → p. 48

→ Top decor

Color concept → p. 52





Order no. 1170-100



5-bolt
lock
system

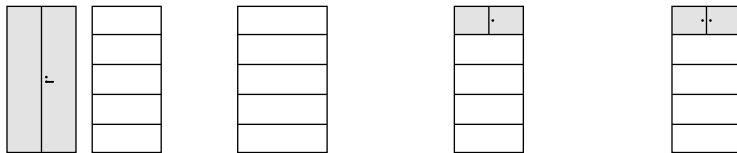

1950	1950	1950	1950
930	1200	930	930
1810 x 878 x 429	1810 x 1148 x 429	1810 x 878 x 429	1810 x 878 x 429
4	4	3	3
Approx. 115 kg	Approx. 140 kg	Approx. 120 kg	Approx. 123 kg
5	5	4	4
-	-	1 (two-door) 335 x 758 x 400	2 (single-door) 335 x 370 x 400
1170-00	1180-00	1170-100	1170-200
1.752,-	2.190,-	1.953,-	1.953,-

877 x 428	1147 x 428	877 x 428	877 x 428
+ 1170-80	+ 1180-80	+ 1170-80	+ 1170-80
+ 33,-	+ 42,50	+ 33,-	+ 33,-



Order no. 1160-000

+ Accessories

Hanging frames and locks → p. 384

Accessories for flame-resistant cabinets

Suspension bars

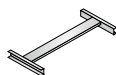
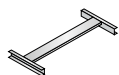

System	Elba/Leitz		Zippel	
For cabinet width	930	1200	930	1200
Inner useful width	825	1095	825	1095
Order no.	1170-82	1180-82	1170-83	1180-83
Price	51,-	60,-	51,-	60,-

Hanging frame

Fully extendable, on ball bearings,
black gray color, with 2 adjustable
dividers, **includes anti-tilt mechanism,**
cannot be retrofitted

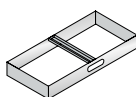

For cabinet width	930	1200
For cabinet depth	500	500
Inner useful depth	328	328
Rows	2-row	2-row and 1 extra compartment
For files	DIN A4	DIN A4
Order no.	1170-8110	1180-8110
Price	230,-	236,-



Additional accessories

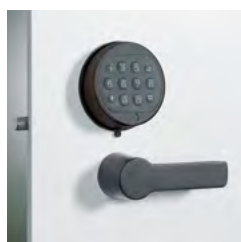

Version	Electronic lock	Single or spare key	Handle silver anodized
	In black (instead of double-bit lock)		
Order no.	1131-02	1128-3399	1170-701
& addtl. charge	390,-	93,-	105,-



Company

Color concept

Changing room & wardrobe

Workshop & factory

Office & archive

Sliding-door cabinets

Space-saving and tidy.



Acurado series

The attractively priced and spacing-saving sliding-door cabinets

- + Sturdy steel construction with high-quality enamel coating
- + With sliders for floor protection as standard
- + Shelves, coated light gray
- + Push and turn cylinder lock with 2 keys and optional exchangeable cylinder
- + Easy to move sliding doors with long-lasting special casters
- + Complete product line (different dimension variants and interior fittings for every requirement)



To the products →



Asisto series

The attractive and flexible space savers

- + Sturdy steel construction with high-quality enamel coating
- + Appealing design thanks to narrow edges
- + Sliders for floor protection, as standard with level adjustment, adjustable from inside
- + Metal cabinet handles, matt nickel-plated
- + Shelves, coated black gray
- + Safety lock (push and turn cylinder lock) with exchangeable cylinder, 2 keys
- + Easy to move sliding doors with long-lasting special casters
- + Doors with wood decor fronts as standard, also available in steel (exchangeable door front concept)
- + Complete product line (different dimension variants and interior fittings for every requirement)



Hinged-door cabinets → p. 356



Tambour cabinets → p. 400

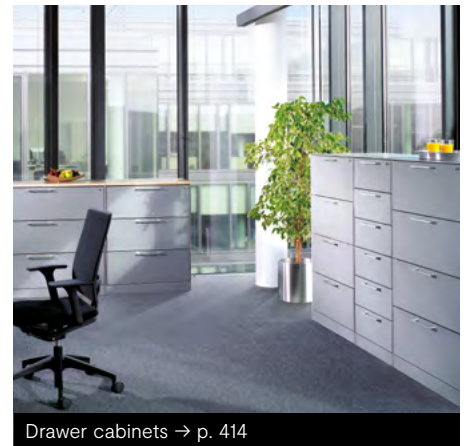

Drawer cabinets → p. 414

Acurado

Sliding-door cabinets with steel doors.

Features of the Acurado sliding-door cabinets:

- + Sturdy steel construction with high-quality enamel coating
- + Wide range of different dimensions for any application
- + With sliders for floor protection as standard
- + Shelves, coated light gray
- + Push and turn cylinder lock with 2 keys and optional exchangeable cylinder
- + Easy to move sliding doors with long-lasting special casters
- + Highly flexible interior fitting options thanks to adjustability in 15 mm steps
- + Interesting range of counter and top solutions
- + High load capacity of 70 kg per shelf, reinforced shelf can bear loads up to 110 kg, for reinforcement see page 394



Order no. 2140-00

Sample visualization of the functional floor space required by space-saving cabinet types (The example does not take into account the possibility of overlapping traffic areas according to regulations.)

- = Functional area
- = User area
- = Traffic area

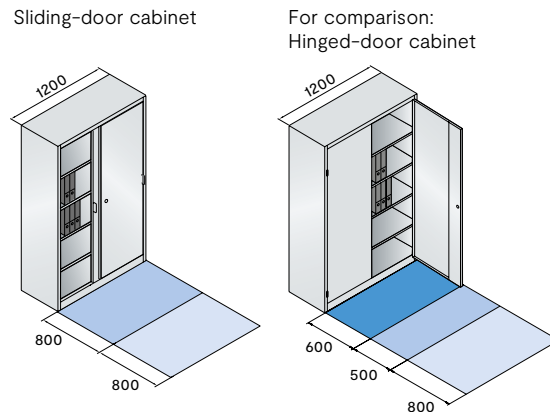

Dimensions and version

Adjustable shelves

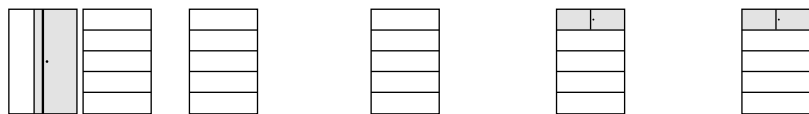

Height: 1,950	Width	1200	1200	1200	1200	1200
	Depth	400	500	600	400	500
	Interior dimensions, HxWxD	1840 x 1197 x 328	1840 x 1197 x 428	1840 x 1197 x 528	1840 x 1197 x 328	1840 x 1197 x 428
	Shelves	4	4	4	3	3
	Center partition	-	-	-	-	-
	Suspension bars	-	-	-	-	-
	Security compartments single-door (per side)	-	-	-	2 400 x 595 x 290	2 400 x 595 x 390
	Order no.	2040-00	2050-00	2060-00	2040-200	2050-200
	Price	952,-	1.095,-	1.286,-	1.315,-	1.458,-

→ Body and door color

Color concept → p. 48



Order no. for top cabinet above: 2045-00/2145-00
 Order no. for basic cabinets below: 2040-00/2140-00



Order no. for top cabinet above: 2044-00/2144-00
 Order no. for basic cabinets below: 2040-00/2140-00

1200	1600	1600	1600	1600	1600	1600
500	400	500	600	400	500	500
1840 x 1197 x 428	1840 x 1596 x 328	1840 x 1596 x 428	1840 x 1596 x 528	1840 x 1596 x 328	1840 x 1596 x 428	1840 x 1596 x 428
-	2 x 4	2 x 4	2 x 4	2 x 3	2 x 3	-
-	1	1	1	1	1	1
6 (Elba/Leitz)	-	-	-	-	-	2 x 6 (Elba/Leitz)
-	-	-	-	2 400 x 795 x 290	2 400 x 795 x 390	-
2050-60	2140-00	2150-00	2160-00	2140-100	2150-100	2150-60
1.095,-	1.231,-	1.408,-	1.644,-	1.594,-	1.771,-	1.408,-

+ Accessories

Additional shelves and underframes → p. 394

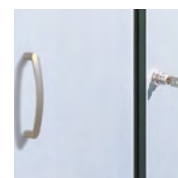

Ergonomic bow-shaped handles:
 Made of metal for easy operation.

Acurado

Top cabinets with steel sliding doors.



Order no. 2044-00 (top cabinet)

Dimensions and version

Incl. accessories for mounting to underbench cabinet, requires tops for use as occasional cabinets

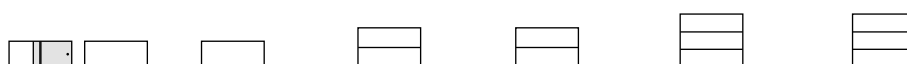

Height	500	500	790	790	1000	1000
Width	1200	1200	1200	1200	1200	1200
Depth	400	500	400	500	400	500
Interior dimensions, HxWxD	450 x 1197 x 328	450 x 1197 x 428	740 x 1197 x 328	740 x 1197 x 428	950 x 1197 x 328	950 x 1197 x 428
Shelves	-	-	1	1	2	2
Binder heights	1	1	2	2	2 + Restfach	2 + Restfach
Order no.	2044-00	2054-00	2045-00	2055-00	2046-00	2056-00
Price	565,-	649,-	706,-	811,-	706,-	811,-

→ Customer must provide wall mounting for top cabinets

Top covers made of MCPB, 25 mm thick, for use as occasional cabinet

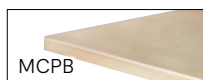

For cabinet width	1200	1200	1200	1200	1200	1200
Depth	400	500	400	500	400	500
& order no.	+ 2016-000	+ 2017-000	+ 2016-000	+ 2017-000	+ 2016-000	+ 2017-000
& unit price	+ 137,-	+ 141,-	+ 137,-	+ 141,-	+ 137,-	+ 141,-

→ **Body and door color**

Color concept → p. 48

→ **Top decor**

Color concept → p. 52



Order no. 2045-00/2145-00 (top cabinets)

500	500	790	790	1000	1000
1600	1600	1600	1600	1600	1600
400	500	400	500	400	500
450x1597 x 328	450x1597 x 428	740x1597 x 328	740x1597 x 428	950x1597 x 328	950x1597 x 428
-	-	2 x 1	2 x 1	2	2
1	1	2	2	2 + Restfach	2 + Restfach
2144-00	2154-00	2145-00	2155-00	2146-00	2156-00
750,-	855,-	925,-	1.056,-	925,-	1.056,-
<hr/>					
1600	1600	1600	1600	1600	1600
400	500	400	500	400	500
+ 2018-000	+ 2019-000	+ 2018-000	+ 2019-000	+ 2018-000	+ 2019-000
+ 173,-	+ 188,-	+ 173,-	+ 188,-	+ 173,-	+ 188,-

+ Rear panel reinforcement
For mounting the cabinet on the wall

& order no.	+ 1000-53
& addtl. charge	+ 62,-

+ Accessories

Additional shelves → p. 394

MCPB = Melamine coated particle board

Acurado

Occasional cabinets with steel sliding doors.



Order no. 2147-1200



Order no. 2048-1200

Dimensions and version

Incl. 25 mm-thick MCPB tops

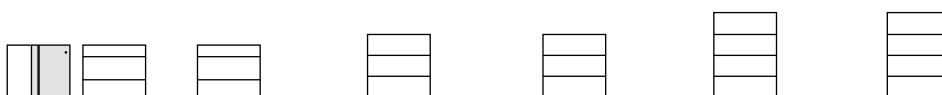

Width: 1,200							
Height	1000	1000	1200	1200	1600	1600	
Depth	400	500	400	500	400	500	
Shelves	2	2	2	2	3	3	
Binder heights	2 1/2	2 1/2	3	3	4	4	
Interior dimensions, HxWxD	855 x 1197 x 328	855 x 1197 x 428	1055 x 1197 x 328	1055 x 1197 x 428	1455 x 1197 x 328	1455 x 1197 x 428	
Order no.	2046-1200	2056-1200	2047-1200	2057-1200	2048-1200	2058-1200	
Price	786,-	892,-	857,-	973,-	998,-	1.135,-	

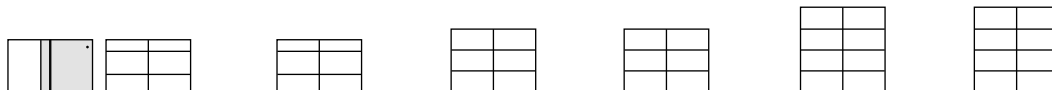

Width: 1,600							
Height	1000	1000	1200	1200	1600	1600	
Depth	400	500	400	500	400	500	
Shelves	2x2	2x2	2x2	2x2	2x3	2x3	
Center partition	1	1	1	1	1	1	
Binder heights	2 1/2	2 1/2	3	3	4	4	
Interior dimensions, HxWxD	855 x 1596 x 328	855 x 1596 x 428	1055 x 1596 x 328	1055 x 1596 x 428	1455 x 1596 x 328	1455 x 1596 x 428	
Order no.	2146-1200	2156-1200	2147-1200	2157-1200	2148-1200	2158-1200	
Price	1.006,-	1.137,-	1.093,-	1.237,-	1.268,-	1.439,-	

→ Body and door color

Color concept → p. 48

→ Top decor

Color concept → p. 52





Dimensions and version

Desk height, adjustable level,
adjustable shelves,
1,200 and 1,600 mm in width,
with center partition,
with 25 mm-thick MCPB top



		800	1000	1200	1600
Height: 720	Width	800	1000	1200	1600
Depth: 400	Shelves	1	1	2 (1 per side)	2 (1 per side)
	Binder heights	2	2	2	2
	Interior dimensions, HxWxD	675 x 740 x 340	675 x 940 x 340	675 x 564 x 340	675 x 764 x 340
	Order no.	5722-00	5725-00	5723-00	5724-00
	Price	536,-	621,-	756,-	925,-

+ Additional SLIM shelves

		800	1000	1200	1600
 <p>Steel shelves</p>	For cabinet width	800	1000	1200	1600
	Width x depth	740 x 340	940 x 340	563 x 340	740 x 340
	Center partition	-	-	1	1
	& order no.	+ 5722-80	+ 5725-80	+ 5723-80	+ 5724-80
	& unit price	+ 52,-	+ 56,-	+ 48,-	+ 52,-

+ Underframes made of square tube, 150 mm high, adjustable level, black gray RAL 7021, other colors on request

		800	1000	1200	1600
	For cabinet width	800	1000	1200	1600
	& order no.	+ 2026-00	+ 2031-00	+ 2027-00	+ 2029-00
	& unit price	+ 125,-	+ 140,-	+ 158,-	+ 186,-

+ Accessories

Additional shelves → p. 394

MCPB = Melamine coated particle board

Acurado

Accessories for sliding-door cabinets.

Additional shelves

Coated steel, light gray

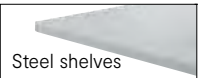
	For cabinet dimensions	1200 x 400	1200 x 500	1600 x 400	1600 x 500
	Width x depth	1196 x 327	1196 x 427	796 x 327	796 x 427
	Center partition	-	-	1	1
	Order no.	2040-80	2050-80	2140-80	2150-80
	Unit price	42,50	45,-	31,50	33,-

Binder supports

Attachable, with 2-fold edging, suitable for all shelves

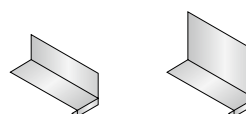

Reinforced shelf

		Height	100	200
Load capacity per shelf	110 kg	Depth/Width x Depth	100 x 230	100 x 270
Order no.	...-802	Order no.	4221-25	4222-25
Price	Double the shelf price	Price	25,-	28,-

Suspension bars

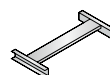
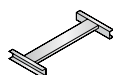

System	Elba/Leitz		Zippel	
For cabinet width	1200	1600	1200	1600
For cabinet depth	500	500	500	500
Inner useful width	1111	731	1111	731
Order no.	2050-82	2150-82	2050-83	2150-83
Price	62,-	49,-	62,-	49,-



Suspension bars for Elba/Leitz system, (order no. 2050-82, 2150-82)

Underframes

150 mm high, square tube, adjustable level. Black gray RAL 7021, other colors on request

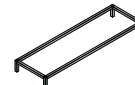
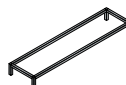
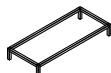
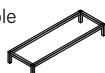

For cabinet width	1200	1200	1600	1600
For cabinet depth	400	500	400	500
Order no.	2027-00	2028-00	2029-00	2030-00
Price	158,-	173,-	186,-	204,-

Shelf with coat rack rail

Below the shelf, possible from 500 mm exterior cabinet depth only, without coat hangers

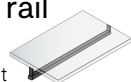

Includes holder	
Order no.	...-88
Price	On request

Shelf support set

Zinc-plated, pack. unit: 20 pc.

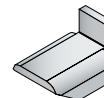

Order no.	1118-00-20
Price	20,-

Keys and locks



	Simultaneously locking	Exchangeable cylinder for master key system	Master key for exchangeable cylinder	Removal key for exchangeable cylinder	Single/spare key for Acurado series	Lock with lock no. upon request (longer delivery times)
Order no.	2025-021	2025-03	2025-031	2025-026	0005-10	...-...99
Price	17,-	17,-	18,-	19,-	19,-	On request

Asisto

Sliding-door cabinets.

Features of the sliding-door cabinets:

- + Sturdy steel construction with high-quality enamel coating
- + Appealing design thanks to narrow edges which you can only achieve with intelligently manufactured steel bodies
- + Excellent stability and suitability for moving thanks to the Asisto steel body (with useful magnetic surfaces on the side)
- + Sliders for floor protection, as standard with level adjustment, adjustable from inside
- + Metal cabinet handles, matt nickel-plated
- + Shelves, coated black gray
- + Safety lock (push and turn cylinder lock) with exchangeable cylinder, 2 keys
- + Easy to move sliding doors with long-lasting special casters
- + Different fronts (steel, wood) and tops can be matched to the steel body
- + Highly flexible interior fitting options thanks to adjustability in 15 mm steps
- + High load capacity of 70 kg per shelf
- + MCPB tops, 25 mm thick, for cabinets up to 1,635 mm in height



Order no. 142002-000
& 142002-710 (steel doors)

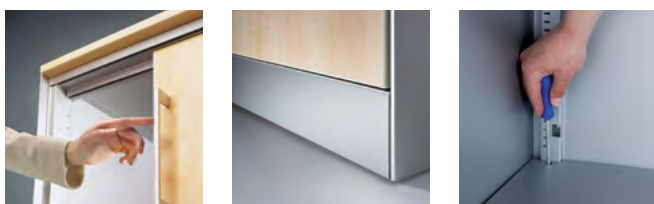

Dimensions and door material

Incl. 25 mm-thick MCPB tops for cabinet heights up to 1,635 mm, **without** center partition, adjustable shelves

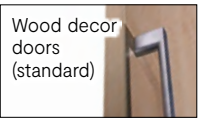

Depth: 435	Height	915	915	1310	1310
	Width	1000	1200	1000	1200
	Interior dimensions, HxWxD	745 x 995 x 352	745 x 1195 x 352	1140 x 995 x 352	1140 x 1195 x 352
	Shelves	1	1	2	2
	Binder heights	2	2	3	3
	Order no.	142052-000	142051-000	142032-000	142031-000
	Price	931,-	1.058,-	1.117,-	1.270,-

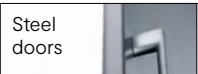
	Optional:				
	& order no.	+ 142052-710	+ 142051-710	+ 142032-710	+ 142031-710
	& addtl. charge	+ 75,-	+ 75,-	+ 75,-	+ 75,-

→ Body and door color

Color concept → p. 48

→ Door decor (possibly top decor) or door color (with steel doors)

Color concept → p. 50



Company

Color concept

Changing room & wardrobe

Workshop & factory

Office & archive

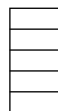

1635
1000
1465 x 995 x 352
3
4
142012-000
1.210,-

1635
1200
1465 x 1195 x 352
3
4
142011-000
1.375,-

1980
1000
1825 x 995 x 352
4
5
142002-000
1.257,-

1980
1200
1825 x 1195 x 352
4
5
142001-000
1.428,-

+ 142012-710
+ 96,-

+ 142011-710
+ 96,-

+ 142002-710
+ 96,-

+ 142001-710
+ 96,-

+ Alternative top covers

Solid-core/HPL or steel → p. 398

+ Sound absorption

Sandwich construction in the side walls → p. 398

+ Accessories

Shelves and binder support → p. 398

Asisto

Accessories for sliding-door cabinets.

Additional shelves

Coated steel, black gray (standard),
load capacity: 70 kg

 <p>Steel</p>	For cabinet width	1000	1200
	Width x depth	994 x 352	1194 x 352
	Order no.	140002-80	140001-80
	Unit price	34,-	43,-



Binder support

Attachable,
for steel shelves,
black gray

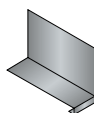

Order no.	140000-701
Price	28,-

Sound absorption

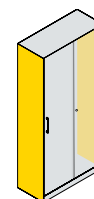
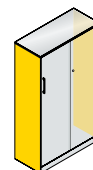
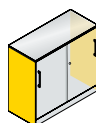

In the side walls, for all cabinet widths,
for a more pleasant sound behavior of the
cabinet



 <p>Sandwich construction (steel-absorption layer-steel)</p>	For cabinet height	915	1310	1635	1980
	Binder heights	2	3	4	5
	Order no.	141050-701	141030-701	141010-701	141000-701
	& addtl. charge	83,-	101,-	118,-	136,-

Alternative top covers

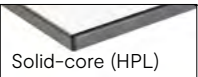
As solid-core/HPL or steel top,
instead of MCPB top

 <p>Solid-core (HPL)</p>	For cabinet width	1000	1200
	Depth	435	435
	Thickness	13	13
	Order no.	140002-130	140001-130
	& addtl. charge	131,-	151,-
 <p>Steel</p>	Thickness	7	7
	Order no.	140002-110	140001-110
	& addtl. charge	0,-	0,-

→ **Body color**

Color concept → p. 48

HPL = High-pressure laminate
MCPB = Melamine coated particle board



Company

Color concept

Changing room & wardrobe

Workshop & factory

Office & archive

Tambour cabinets

More room in less space.



Omnispace series

The affordable complete tambour cabinet range

- + Body in sturdy steel construction with high-quality enamel coating
- + Sliders for floor protection, as standard with level adjustment, adjustable from inside
- + Shelves, coated black gray
- + Hook bolt lock with 2 keys
- + Plastic tambour doors made of polypropylene with recessed grip, smooth and quiet functioning
- + Complete product line (different dimension variants and interior fittings for every requirement)





Asisto series

**The elegant single-door cabinets:
Flexible and especially easy to move**

- + Body in sturdy steel construction with high-quality enamel coating
- + Appealing design thanks to narrow edges
- + Sliders for floor protection, as standard with level adjustment, adjustable from inside
- + Shelves, coated black gray
- + Hook bolt lock with exchangeable cylinders, 2 keys
- + Plastic tambour doors, hinged on the left, with matt nickel-plated bow-shaped handle, especially smooth and quiet functioning
- + Doors also available with sound-absorbing acoustic tambour
- + Complete product line (different dimension variants and interior fittings for every requirement)



Hinged-door cabinets → p. 356



Sliding-door cabinets → p. 386

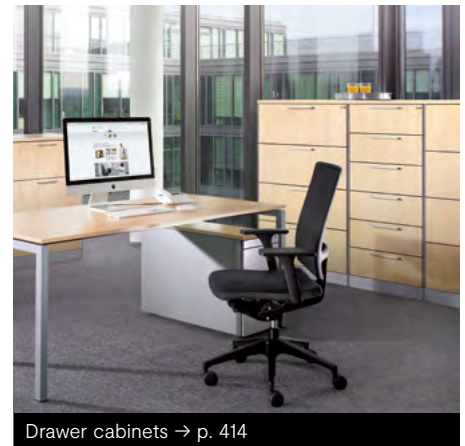

Drawer cabinets → p. 414

Omnispace series

Tambour cabinets.

The Omnispace series offers:

- + Body in sturdy steel construction with high-quality enamel coating
- + Planning dimensions: 600, 800, 1,000 and 1,200 mm
- + Sliders for floor protection, as standard with level adjustment, adjustable from inside
- + No assembly required—tambour cabinets are delivered fully assembled
- + Shelves, coated black gray
- + Body and internal walls have the same color
- + Hook bolt lock with 2 keys
- + Tambour doors consist of full-length, flexible plastic mats (polypropylene) with a practical recessed grip for easy operation
- + Tambours move smoothly and quietly
- + Highly flexible interior fitting options thanks to adjustability in 15 mm steps
- + Load capacity of 50 kg per shelf



Order no. 3200-088L



Order no. 3203-00



Dimensions and version

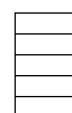
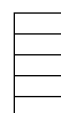
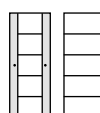
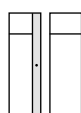
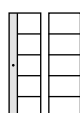
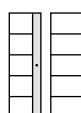

Height: 1980 Depth: 420	Width	600	600	600	800	1000	1200
	Interior dimensions, HxWxD	1836 x 493 x 385	1836 x 493 x 385	1836 x 493 x 385	1836 x 651 x 385	1836 x 851 x 385	1836 x 1051 x 385
	Shelves	4	4	1	4	4	4
	Binder heights	5	5	-	5	5	5
	Description	Tambour door stopping on left	Tambour door stopping on right	Stopping on left with extendable coat rack rail	-	-	-
	Order no.	3200-00L	3200-00R	3200-088L	3201-00	3202-00	3203-00
	Price	648,-	648,-	602,-	724,-	838,-	952,-



+ Top cabinets

Selection → p. 406

→ Body color

Color concept → p. 48

→ Tambour fronts

Color concept → p. 406

+ Accessories

Extendable coat rack rail → p. 407



Company

Color concept

Changing room & wardrobe

Workshop & factory

Office & archive

Tambour cabinet

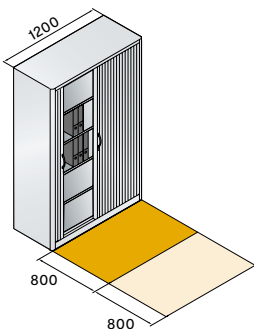

For comparison: Hinged-door cabinet

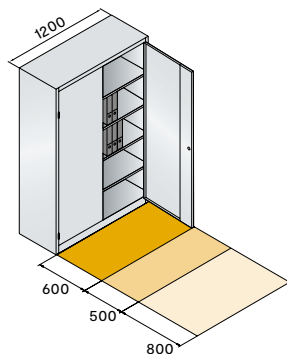

- = Functional area
- = User area
- = Traffic area

Sample visualization of the functional floor space required by space-saving cabinet types (The example does not take into account the possibility of overlapping traffic areas according to regulations)

Omnispace series

Tambour cabinets.

Dimensions and version

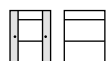

Depth: 420

Height	1030	1030	1030
Width	800	1000	1200
Interior dimensions, HxWxD	886 x 651 x 385	886 x 851 x 385	886 x 1051 x 385
Shelves	2	2	2
Binder heights	2 + extra compartment	2 + extra compartment	2 + extra compartment
Order no.	3241-00	3242-00	3243-00
Price	536,-	621,-	706,-



Depth: 420

Height	1345	1345	1345
Width	800	1000	1200
Interior dimensions, HxWxD	1201 x 651 x 385	1201 x 851 x 385	1201 x 1051 x 385
Shelves	3	3	3
Binder heights	3 + extra compartment	3 + extra compartment	3 + extra compartment
Order no.	3221-00	3222-00	3223-00
Price	644,-	745,-	847,-



+ **Top covers**
25 mm thick, in MCPB,
please specify top decor

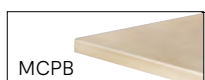

MCPB = Melamine coated particle board

For cabinet width	800	1000	1200
Depth	420	420	420
& order no.	+ 3212-0800	+ 3212-1000	+ 3212-1200
& addtl. charge	+ 98,-	+ 112,-	+ 126,-



Standard level adjustment:
For Omnispace tambour cabinets,
height adjustable up to 10 mm
+ Easy to access
+ Easy to adjust

→ **Body color**

Color concept → p. 48

→ **Top decor**

Color concept → p. 52

→ **Tambour fronts**

Color concept → p. 406

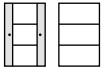

1230
800
1086 x 651 x 385
2
3
3231-00
590,-



1230
1000
1086 x 851 x 385
2
3
3232-00
683,-



1230
1200
1086 x 1051 x 385
2
3
3233-00
776,-

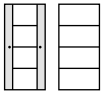

1660
800
1516 x 651 x 385
3
4
3211-00
697,-



1660
1000
1516 x 851 x 385
3
4
3212-00
807,-



1660
1200
1516 x 1051 x 385
3
4
3213-00
917,-



Order no. 3213-00



Order no. 3243-00 & 57700-701



Order no. 3233-00 & 3212-1200 (top cover)



+ Accessories







Suspension bars → p. 407

Omnispace series

Top and occasional cabinets.

Dimensions and version



Top cabinets

					
Height: 450 Depth: 420	Width: 600	600	800	1000	1200
	Interior dimensions, HxWxD: 356 x 493 x 385	356 x 493 x 385	356 x 651 x 385	356 x 851 x 385	356 x 1051 x 385
	Description: Tambour door stopping on left	Tambour door stopping on right	-	-	-
	Order no.: 3260-00L	3260-00R	3261-00	3262-00	3263-00
	Price: 384,-	384,-	429,-	497,-	565,-

+ Wall mount
Customer must provide wall mount for top cabinets

Occasional cabinets

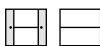
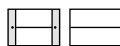
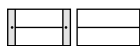
Desk height
incl. 25 mm-thick MCPB top

			
Height: 720 Depth: 420	Width: 800	1000	1200
	Interior dimensions, HxWxD: 596 x 651 x 385	596 x 851 x 385	596 x 1051 x 385
	Shelves: 1	1	1
	Binder heights: 1 + extra compartment	1 + extra compartment	1 + extra compartment
	Order no.: 3251-00	3252-00	3253-00
	Price: 617,-	702,-	786,-



Available colors and materials

Available **body colors** (please note: additional charge for body in white aluminum, see C + P color concept on Page 48/49)

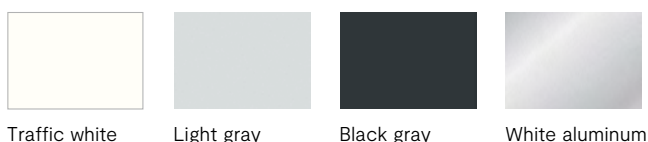

The smooth-running **plastic tambour mats** are made of polypropylene and are available for all cabinet heights in the following colors at no additional charge:

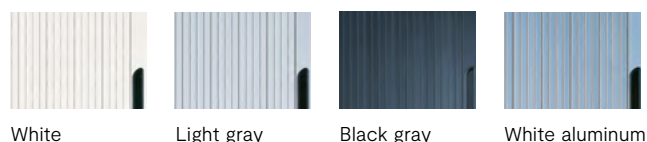

Top covers

25 mm thick with 3 mm edge band available in 3 decors:



MCPB = Melamine coated particle board
Master key system—price on request

Omnispace series

Accessories for tambour cabinets.

Set of casters (4 pc.)

For 720 and 1,030 mm-high cabinets only.
4 casters, both front casters with lock.



Order no.	57700-701
Price	139,-

Additional shelves

Coated steel, black gray (standard)

Steel shelves	For cabinet width	600	800	1000	1200
	Width x depth	493 x 360	651 x 360	851 x 360	1051 x 360
	Order no.	3200-80	3201-80	3202-80	3203-80
	Price	23,-	27,-	29,-	33,50

Suspension bars

(Suspension bars from other systems on request)

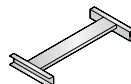
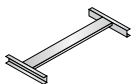

	Elba/Leitz				Zippel			
	600	800	1000	1200	600	800	1000	1200
For cabinet width	600	800	1000	1200	600	800	1000	1200
Order no.	3200-82	3201-82	3202-82	3203-82	3200-83	3201-83	3202-83	3203-83
Price	39,-	44,50	51,-	56,-	39,-	44,50	51,-	56,-



Hanging frame

Fully extendable,
max. 4 hanging frames per cabinet possible, color black gray RAL 7021

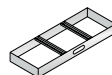

For DIN A4 suspension files (incl. anti-tilt mechanism, cannot be retrofitted!)			
For locker width	800	1000	1200
Rows	1-row	2-row	3-row
Order no.	3201-811	3202-811	3203-811
Price	214,-	225,-	237,-



Shelf with coat rack rail

Extendable, below the shelf, without coat hangers



For cabinet width	600	800
Order no.	3200-88	3201-88
Price	46,-	54,-



Binder support

Attachable, suitable for all shelves



Single/ spare key



Lock

Simultaneous locking



Order no.	3200-701	Order no.	3200-7027	Order no.	3200-7021
Price	28,-	Price*	19,-	Price*	17,-

*When ordering for cabinet

Asisto

Tambour cabinets

Features of Asisto tambour cabinets:

- + Body in sturdy steel construction with high-quality enamel coating
- + Appealing design thanks to narrow edges which you can only achieve with intelligently manufactured steel bodies
- + Excellent stability and suitability for moving thanks to the Asisto steel body (with useful magnetic surfaces on the side)
- + Sliders for floor protection, as standard with level adjustment, adjustable from inside
- + No assembly required—tambour cabinets are delivered fully assembled
- + Shelves, coated black gray
- + Hook bolt lock with exchangeable cylinders, 2 keys
- + Tambour doors consist of full-length, flexible plastic mats (polypropylene) with aluminum locking bar and metal cabinet handle, matt nickel-plated, for easy operation
- + Tambours move especially smoothly and quietly
- + Doors also available with sound-absorbing acoustic tambour
- + Highly flexible interior fitting options thanks to adjustability in 15 mm steps
- + Load capacity of 50 kg per shelf
- + MCPB tops, 25 mm thick, for cabinets up to 1,635 mm in height

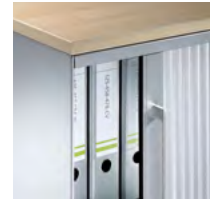

Patented acoustic tambour:
Absorb sound, improve acoustics—and look good doing it: The light-running, patented and award-winning special tambour absorbs a majority of the sound occurring in day-to-day work. In some frequency ranges, it “swallows” almost seven times as much sound as a conventional cabinet.



+ Optional for all cabinets:
Make the office an area of tranquility!
“Typical” background noise is part and parcel of the day-to-day routine in open-concept offices: Talking, clatter and ringing hamper concentration while working. All the better if you can solve this problem by utilizing the office storage you need anyway and create a healthy, pleasant working atmosphere for employees at the same time.

Tambour cabinets for efficient office space utilization

When open, tambour cabinets always provide unobstructed access without the hindrance of doors extending into the room. This allows you to

- + fit more workstations and storage space in the room
- + or achieve a more generous appearance of your furnishings while using the same amount of space,
- + utilizing valuable office space more efficiently!

Tambour cabinet

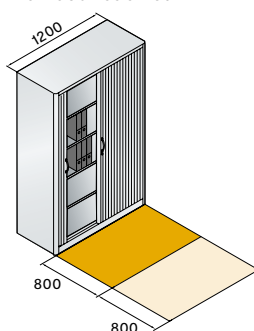

For comparison: Hinged-door cabinet

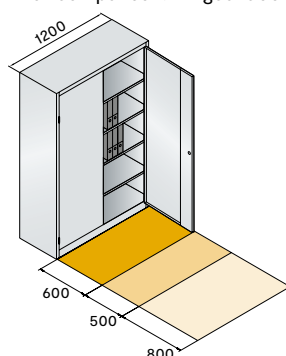

- = Functional area
- = User area
- = Traffic area

Sample visualization of the functional floor space required by space-saving cabinet types (The example does not take into account the possibility of overlapping traffic areas according to regulations)



Also available with **acoustically effective tambour doors**

Order no. 143001-000 & 143001-716 (acoustic tambour)



Order no. 143002-000

Dimensions and tambour material

Adjustable shelves

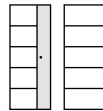

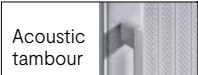
	Width	800	1000	1200
Height: 1,980	Interior dimensions, H x W x D	1865 x 695 x 365	1865 x 895 x 365	1865 x 1095 x 365
Depth: 435	Shelves	4	4	4
 Standard tambour	Binder heights	5	5	5
	Order no.	143003-000	143002-000	143001-000
	Price	1.086,-	1.257,-	1.428,-
 Acoustic tambour	Optional:	-	-	-
	& order no.	-	-	+ 143001-716
	& addtl. charge	-	-	+ 1.603,-

+ Accessories

Additional shelves, hanging frames and binder support → p. 412

→ Body color

Color concept → p. 48

→ Tambour fronts

Please choose from white, light gray, black gray and white aluminum (acoustic tambour only available in white and white aluminum)

Color concept → p. 413

Asisto

Tambour cabinets.



Order no. 143053-000



Order no. 143012-000

Dimensions and tambour material

Incl. MCPB tops, 25 mm thick, adjustable shelf

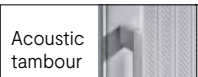

 <p>Standard tambour</p>	Height	915	915	915
	Width	800	1000	1200
	Interior dimensions, HxWxD	785x695x365	785x895x365	785x1095x365
	Shelves	1	1	1
	Binder heights	2	2	2
	Order no.	143053-000	143052-000	143051-000
	Price	804,-	931,-	1.058,-
 <p>Acoustic tambour</p>	Optional:	-	-	+ 143051-716
	& order no.	-	-	+ 143051-716
	& addtl. charge	-	-	+ 911,-



Tambour fronts

Please choose from white, light gray, black gray and white aluminum (acoustic tambour only available in white and white aluminum)

→ Body color

Color concept → p. 48

Color concept → p. 413



Company

Color concept

Changing room & wardrobe

Workshop & factory

Office & archive



1310	1310	1310	1635	1635	1635
800	1000	1200	800	1000	1200
1176x695x365	1176x895x365	1176x1095x365	1505x695x365	1505x895x365	1505x1095x365
2	2	2	3	3	3
3	3	3	4	4	4
143033-000	143032-000	143031-000	143013-000	143012-000	143011-000
965,-	1.117,-	1.270,-	1.045,-	1.210,-	1.375,-

-	-	+ 143031-716	-	-	+ 143011-716
-	-	+ 1.139,-	-	-	+ 1.383,-

MCPB = Melamine coated particle board

+ Accessories



Alternative top covers and additional shelves → p. 412

Asisto

Accessories for tambour cabinets.

Alternative top covers

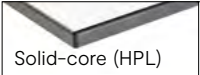
As **solid-core/HPL** or **steel top**, instead of MCPB top

Depth: 435	For cabinet width	800	1000	1200
 <p>Solid-core (HPL)</p>	Thickness	13	13	13
	Order no.	140003-130	140002-130	140001-130
	& addtl. charge	114,-	131,-	151,-
 <p>Steel</p>	Thickness	7	7	7
	Order no.	140003-110	140002-110	140001-110
	& addtl. charge	0,-	0,-	0,-

Additional shelves

Coated steel, black gray (standard)

	For cabinet width	800	1000	1200
	Width x depth	724 x 363	924 x 363	1124 x 363
	Order no.	143003-80	143002-80	143001-80
	Price	32,-	34,-	43,-

Hanging frame

Fully extendable, on ball bearings, with 2/4 adjustable vertical fixed links, incl. double anti-tilt mechanism, for DIN A4 files.

Cannot be retrofitted

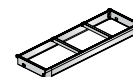
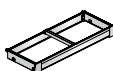

	800	1000	1200
For cabinet width	800	1000	1200
Inner useful depth	330	330	330
Rows	1-row	2-row	3-row
Order no.	143003-811	143002-811	143001-811
Price	252,-	261,-	275,-

Binder support

Attachable, for steel shelves, black gray

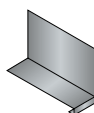

Height	200
Width	100
Depth	270
Order no.	140000-701
Price	28,-

Shelf with coat rack rail

Extendable, below the shelf, without coat hangers



For cabinet width	800
Dimensions, HxWxD	24 x 695 x 355
Interior dimensions, WxD	695 x 365
Order no.	143003-88
Price	64,-

⊕ Top design

Selection → p. 52



Order no. 143001-000

Available colors for tambour

The smooth-running plastic tambour mats are available for all cabinet heights in the following colors at no additional charge:

Standard tambour:

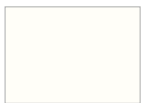

White



Light gray



Black gray



White aluminum

Acoustic tambour:

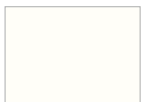

White



White aluminum

Notes on body paint according to the C+P color concept:

Body colors RAL 9016 traffic white, RAL 7035 light gray and RAL 7021 black gray are all in color group 0 and therefore have no surcharge.

The surcharge for body color RAL 9006 white aluminum (color group I) can be found in the C+P color concept on page 48/49.

Drawer and filing cabinets

Order across the board.



Acurado series

**The cost-effective cabinets
for suspension files and index cards**

- + Sturdy steel construction with high-quality enamel coating
- + With sliders for floor protection as standard
- + Integrated full-width handle bar
- + Central locking system with 2 keys and exchangeable cylinder
- + Drawers are fully extendable, with anti-tilt mechanism
- + Load capacity per drawer: 50 kg
- + For DIN A4 suspension files and DIN A4/A5 index cards
- + Available in light gray RAL 7035, black gray RAL 7021, white aluminum RAL 9006 and traffic white RAL 9016

Asisto series

**The convenience range
for all filing tasks**

- + Sturdy steel construction with body sound absorption and high-quality enamel coating
- + Appealing design thanks to narrow edges
- + Sliders for floor protection, as standard with level adjustment, adjustable from inside
- + Elegant and ergonomic bow-shaped handles, matt nickel-plated
- + Optional wood decor fronts and tops
- + Central locking system with 2 keys and exchangeable cylinder
- + Drawers are fully extendable, with anti-tilt mechanism
- + Load capacities per drawer:
 - 50 kg (435 mm deep)
 - 60 kg (600 mm deep)
 - 100 kg (600 mm deep with heavy-duty rails)
- + Complete modular system for different filing materials



To the products →



7000 series

The universal drawer cabinets for everything flat

- + Sturdy steel construction with overlay drawer fronts and high-quality enamel coating
- + With sliders for floor protection as standard
- + Elegant and ergonomic bow-shaped handles, matt nickel-plated
- + Central locking system with 2 keys
- + Drawer, fully (DIN A1) or 4/5 (DIN A0) extendable, with anti-tilt mechanism
- + Load capacity per drawer: 40 kg
- + Drawer bottoms are stepped and can be divided, therefore suitable for different applications
- + Available in two sizes (DIN A1 and DIN A0) and two cabinet heights with different drawer configurations



Hinged-door cabinets → p. 356



Sliding-door cabinets → p. 386



Tambour cabinets → p. 400

Acurado

Suspension file and card-index cabinets.

Features of the Acurado suspension file and index card cabinets:

- + Sturdy steel construction with high-quality enamel coating
- + Economical solution for “classic” office tasks
- + Three heights, three widths
- + With sliders for floor protection as standard
- + Integrated full-width handle bar
- + Central locking system with 2 keys and exchangeable cylinder
- + Fully extendable steel drawers on long-lasting telescopic ball-bearing rails, flush folded in, sealed drawer bottom
- + Anti-tilt mechanism
- + Load capacity per drawer: 50 kg
- + Card-index cabinets with 2 card-index dividers per index row

Dimensions and version

Suspension file cabinets

With hanging frame and sealed drawer bottom, for suspension files of size DIN A4, fully extendable



Depth: 590	Height	733	1045	1357	733	1045	1357
	Width	433	433	433	787	787	787
	Interior dimensions, HxWxD	250 x 330 x 518	250 x 330 x 518	250 x 330 x 518	250 x 330 x 518	250 x 330 x 518	250 x 330 x 518
	Drawers	2	3	4	2	3	4
	Rows	1-row	1-row	1-row	2-row	2-row	2-row
	Order no.	12412-311	12423-311	12434-311	12912-312	12923-312	12934-312
	Price	443,-	476,-	547,-	685,-	741,-	852,-

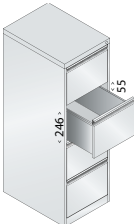

Our interior dimension specifications generally indicate **the usable dimensions** (e.g. from the suspension point of the DIN A4 size suspension file to the next lower panel or drawer bottom).

The usable dimensions from the suspension point to the **next higher** panel are indicated in the drawing above.

Available in the following colors with no surcharge:



+ Accessories

Card-index dividers and underframes → p. 418



Order no. 12434-311 Order no. 12934-312 Order no. 12923-312 Order no. 12912-312

Dimensions and version

Card-index cabinets for DIN A5 and DIN A4 index cards, drawers fully extendable



Depth: 590	Height	1045	1357	1045	1357	1357	1357
	Width	433	433	787	787	553	787
	Interior dimensions, HxWxD	285 x 300 x 518	285 x 300 x 518	285 x 300 x 518	285 x 300 x 518	185 x 214 x 518	185 x 214 x 518
	Drawers	3	4	3	4	6	6
	Rows	1-row	1-row	2-row	2-row	2-row	3-row
	For index cards	DIN A4 landscape	DIN A4 landscape	DIN A4 landscape	DIN A4 landscape	DIN A5 landscape	DIN A5 landscape
	Order no.	12423-321	12434-321	12923-322	12934-322	12736-322	12936-323
	Price	617,-	728,-	882,-	1.033,-	968,-	1.250,-

Based on applicable standards and guidelines (e.g. EN 14073-2), **cabinets must be secured against tipping**. There are two convenient options for this:

- Version with **wall mount*** or
- Version with **additional counterweight**



*The fastening method depends on the wall material. Please use screws and dowels that are suitable for the respective type of wall (not included).

+ Additional counterweight if wall mounting is not possible—cannot be fitted retroactively

For cabinet width	433	553	787
Load capacity per drawer	35 kg	40 kg	50 kg
& order no.	+ 6400-01	+ 6700-01	+ 6900-01
& addtl. charge	+ 57,-	+ 69,-	+ 105,-



Order no. 12736-322 Order no. 12936-323

Acurado

Accessories for drawer and filing cabinets.

Label holder

Made of plastic, per piece



Label holder
Transparent, incl. white label (1 pc. per drawer as standard)

Standard
For supplementation of the included inscription fields. Color black, incl. label and transparent cover

Comfort
As an alternative to additional drawer labeling. Color black, incl. label and transparent cover

Version	Self-adhesive	Self-adhesive	Self-adhesive	Magnetic
H x W x D	32 x 100 x 2	26 x 76 x 4	39 x 114 x 5	39 x 114 x 5
Window, H x W	26 x 98	17 x 67	30 x 105	30 x 105
Order no.	6103-10	6103-13	6103-11	6103-12
Price	4,-	6,-	15,-	15,-

Underframes

150 mm high, square tube, adjustable level. Black gray RAL 7021, other colors on request



Width	433	553	787
Depth	590	590	590
Order no.	64020-00	67020-00	69020-00
Price	112,-	124,-	136,-

Card-index dividers

Individual

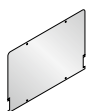

Version	For DIN A4 landscape index cards	For DIN A5 landscape index cards
Panel height	6 HU	4 HU
Order no.	6494-10	6495-10
Unit price	12,-	11,-



All cabinets feature sealed drawer bottoms

Exchangeable lock cylinder

With 2 keys, nickel-plated



Order no.	2025-02
Price	15,-



Cylinder lock with exchangeable cylinder:
As central locking system. Compatible with many other C + P furniture items. Also ideal for subsequent organization of locking groups. Flush steel drawers with integrated, full-width handle bar

Single/spare key

Per pc.

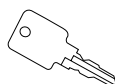

Order no.	0005-10
Price	19,-



Company

Color concept

Changing room & wardrobe

Workshop & factory

Office & archive

Asisto

Drawer and filing cabinets 435 mm deep.

Features of the Asisto 435 mm-deep drawer and filing cabinets:

- + **Cabinet depth: 435 mm, with MCPB panels and top covers as standard, can be combined with Asisto hinged-door, sliding-door and tambour cabinets**
- + Sturdy steel construction with high-quality enamel coating
- + Body with body sound absorption for pleasant sound behavior
- + Appealing design thanks to narrow edges
- + Sliders for floor protection, as standard with level adjustment, adjustable from inside
- + Elegant and ergonomic bow-shaped handles, matt nickel-plated
- + Fronts also available in steel
- + Central locking system with 2 keys and exchangeable cylinder
- + Full extension slides (width: 1,200 mm with parallel control) with self-closing system, anti-tilt mechanism and soft-close silencers as standard
- + Drawers and hanging frames in black gray or graphite black
- + Load capacity per drawer: 50 kg
- + For DIN A4 suspension files and DIN A4/A5 index cards
- + Card-index cabinets with 2 card-index dividers per index row
- + High-quality, self-adhesive plastic label holder with inscription field (1 supplied for each drawer)



Order no. 146041-313

Dimensions and panel material of filing cabinets

With **closed** hanging frame for **DIN A4** suspension files, fully extendable, incl. 25 mm-thick MCPB top

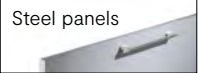

Depth: 435 	Height	1010	1310	1010	1310
	Width	800	800	1200	1200
	Interior dimensions, HxWxD	240x330x320	240x330x320	240x330x320	240x330x320
	Hanging frame	1	1	1	1
	Drawers	3x6 HU	4x6 HU	3x6 HU	4x6 HU
	Rows	2-row	2-row	3-row	3-row
	Order no.	146043-312	146023-412	146041-313	146021-413
	Price	1.328,-	1.550,-	1.547,-	1.808,-

Steel panels 	Optional:				
	& order no.	+ 6900-401	+ 6900-402	+ 6400-401	+ 6400-402
	& addtl. charge	+ 0,-	+ 0,-	+ 0,-	+ 0,-

→ **Body color**

Color concept → p. 48

⊕ **Accessories**

Suspension plates, index row plates, label holder, exchangeable lock cylinder and single key → p. 430

→ **Panel decor (if appl., top decor) or panel color (for steel panels)**

Color concept → p. 50



Company

Color concept

Changing room & wardrobe

Workshop & factory

Office & archive

Dimensions and panel material of card-index cabinets

For **DIN A4** and **DIN A5** index cards, drawers fully extendable, incl. 25 mm-thick MCPB top

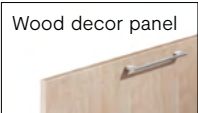

	Width: 800	Height	1010	1310	1310
	Depth: 435	Interior dimensions, HxWxD	260x303x320	260x303x320	160x213x320
		Rows	2-row	2-row	3-row
		Drawers	3 x 6 HU	4 x 6 HU	6 x 4 HU
		For index cards	DIN A4 landscape	DIN A4 landscape	DIN A5 landscape
		Order no.	146043-322	146023-422	146023-623
	Price	1.554,-	1.840,-	2.187,-	

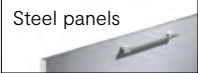
	Optional:			
	& order no.	+ 6900-401	+ 6900-402	+ 6900-402
	& addtl. charge	+ 0,-	+ 0,-	+ 0,-

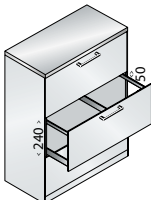

Our interior dimension specifications generally indicate **the usable dimensions** (e.g. from the suspension point of the DIN A4 size suspension file to the next lower panel or drawer bottom). The usable dimensions from the suspension point to the **next higher** panel are indicated in the drawing above.

Based on applicable standards and guidelines (e.g. EN 14073-2), cabinets must be secured against tipping. There are two convenient options for this:



- Version with **wall mount** (please use screws and dowels that are suitable for the respective type of wall)
- Version with an additional **counterweight**

+ Additional counterweight
if wall mounting is not possible—cannot be fitted retroactively

For cabinet width	800	1200	800	1200
For cabinet height	1010	1010	1310	1310
Load capacity per drawer	50 kg	50 kg	50 kg	50 kg
& order no.	+ 6700-01	+ 6700-01	+ 6900-01	+ 6900-01
& addtl. charge	+ 69,-	+ 69,-	+ 105,-	+ 105,-

MCPB = Melamine coated particle board
1 HU = 50 mm (height unit)

Asisto

Drawer and filing cabinets 600 mm deep.

Features of the drawer and filing cabinets:

- + **Cabinet depth of 600 mm, as standard with panels and top covers made of steel**
- + Sturdy steel construction with high-quality enamel coating
- + Body with body sound absorption for pleasant sound behavior
- + Appealing design thanks to narrow edges
- + Sliders for floor protection, as standard with level adjustment, adjustable from inside
- + Elegant and ergonomic bow-shaped handles, matt nickel-plated
- + Optional wood decor fronts and tops
- + Central locking system with 2 keys and exchangeable cylinder
- + Full extension slides on sturdy telescopic rails, with anti-tilt mechanism and self-closing system
- + Drawers and hanging frames in black gray or graphite black
- + Load capacities per drawer: 60 kg with standard rails
100 kg with heavy-duty rails
- + Complete modular system for different filing materials
- + Card-index cabinets with 2 card-index dividers per index row
- + High-quality, self-adhesive plastic label holder with inscription field (1 supplied for each drawer)



Order no. 146243-312

Dimensions and panel material of filing cabinets

With **closed** hanging frame

for **DIN A4** suspension files, fully extendable, incl. 7 mm-thick steel top cover



Depth: 600	Height	698	998	1298	1298
	Width	440	440	440	562
	Interior dimensions, HxWxD	240 x 330 x 518	240 x 330 x 518	240 x 330 x 518	345 x 451 x 518
	Rows	1-row	1-row	1-row	1-row
	Drawers	2 x 6 HU	3 x 6 HU	4 x 6 HU	3 x 8 HU
	For suspension files	DIN A4	DIN A4	DIN A4	DIN A3
	Order no.	146275-211	146245-311	146225-411	146224-301
	Price	726,-	905,-	1.055,-	1.175,-



Steel panels (standard)

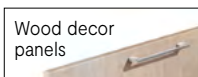

Wood decor panels

Optional:				
& order no.	+ 6400-410	+ 6400-411	+ 6400-412	+ 6700-412
& addtl. charge	+ 0,-	+ 0,-	+ 0,-	+ 0,-

Based on applicable standards and guidelines (e.g. EN 14073-2), **cabinets must be secured against tipping**. There are two convenient options for this:

1. Version with **wall mount*** or
2. Version with **additional counterweight**



*The fastening method depends on the wall material. Please use screws and dowels that are suitable for the respective type of wall (not included).

→ **Body and panel color (for steel panels)**

Color concept → p. 48

→ **Panel/top decor (wood decor panels)**

Color concept → p. 50

+ **Accessories**

Soft-stop and alternative top covers → p. 430



698	998	1298
800	800	800
240 x 330 x 518	240 x 330 x 518	240 x 330 x 518
2-row	2-row	2-row
2 x 6 HU	3 x 6 HU	4 x 6 HU
DIN A4	DIN A4	DIN A4
146273-212	146243-312	146223-412
919,-	1.153,-	1.346,-

+ 6900-410	+ 6900-411	+ 6900-412
+ 0,-	+ 0,-	+ 0,-

(+) **Additional counterweight**
if wall mounting is not possible—cannot be fitted retroactively

For cabinet width	440	562	800	440	800	440	562	800
For cabinet height	698	698	698	998	998	1298	1298	1298
Load capacity per drawer	35 kg	35 kg	50 kg	35 kg	50 kg	50 kg	50 kg	50 kg
& order no.	+ 6400-01	+ 6700-01	+ 6900-01	+ 6400-01	+ 6900-01	+ 6400-01	+ 6700-01	+ 6900-01
& addtl. charge	+ 57,-	+ 69,-	+ 105,-	+ 57,-	+ 105,-	+ 57,-	+ 69,-	+ 105,-

Cabinet heights

For top covers

in steel (standard)

1298
998
698
or
MCPB (see Page 431)
1316
1016
716

MCPB = Melamine coated
particle board
1 HU = 50 mm (height unit)

Asisto

Drawer cabinets, 600 mm deep.



Order no. 146224-321



Order no. 146243-322
& 69011-000 (MCPB top cover, optional)

Dimensions and panel material of card-index cabinets, 600 mm deep

For **DIN A4** and **DIN A3** index cards, drawers fully extendable, incl. 7 mm-thick steel top cover

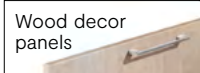

 <p>Steel panels (standard)</p>	Depth: 600	Height	698	998	1298
		Width	440	440	440
		Interior dimensions, HxWxD	285 x 300 x 518	285 x 300 x 518	285 x 300 x 518
		Rows	1-row	1-row	1-row
		Drawers	2 x 6 HU	3 x 6 HU	4 x 6 HU
		For index cards	DIN A4 landscape	DIN A4 landscape	DIN A4 landscape
		Order no.	146275-221	146245-321	146225-421
	Price	855,-	1.131,-	1.345,-	

 <p>Wood decor panels</p>	Optional:			
	& order no.	+ 6400-410	+ 6400-411	+ 6400-412
	& addtl. charge	+ 0,-	+ 0,-	+ 0,-

→ **Body and panel color (for steel panels)**

Color concept → p. 48

→ **Panel/top decor (wood decor panels)**

Color concept → p. 50







Company

Color concept

Changing room & wardrobe

Workshop & factory

Office & archive

				
698	998	1298	1298	1298
800	800	800	562	562
285x300x518	285x300x518	285x300x518	390x429x518	390x214x518
2-row	2-row	2-row	1-row	2-row
2x6 HU	3x6 HU	4x6 HU	3x8 HU	3x8 HU
DIN A4 landscape	DIN A4 landscape	DIN A4 landscape	DIN A3 landscape	DIN A4 portrait
146273-222	146243-322	146223-422	146224-321	146224-322
1.048,-	1.378,-	1.636,-	1.400,-	1.428,-

*Cabinet heights incl. MCPB tops + 18 mm in each case

+ 6900-410	+ 6900-411	+ 6900-412	+ 6700-412	+ 6700-412
+ 0,-	+ 0,-	+ 0,-	+ 0,-	+ 0,-

MCPB = Melamine coated particle board

+ Tops covers*

MCPB (wood decor) instead of steel top → p. 430

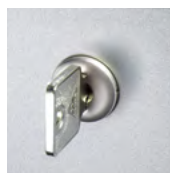

+ Accessories

Central locking system with exchangeable cylinder → p. 430

Compatible with many other C+P furniture items. Also ideal for subsequent organization of locking groups.

! All dimensions in mm, and all prices in Euros

Asisto

Drawer cabinets, 600 mm deep.

Dimensions and panel material

Card-index cabinets, 600 mm deep

For **DIN A5 index cards**, drawers fully extendable, incl. 7 mm-thick steel top cover

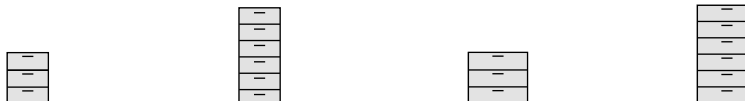

	Depth: 600	Height	698	1298	698	1298
		Width	562	562	800	800
		Interior dimensions, HxWxD	185 x 214 x 518	185 x 214 x 518	185 x 214 x 518	185 x 214 x 518
		Rows	2-row	2-row	3-row	3-row
		Drawers	3 x 4 HU	6 x 4 HU	3 x 4 HU	6 x 4 HU
		For index cards	DIN A5 landscape	DIN A5 landscape	DIN A5 landscape	DIN A5 landscape
		Order no.	146274-322	146224-622	146273-323	146223-623
		Price	1.080,-	1.791,-	1.197,-	1.983,-

	Optional:				
	& order no.	+ 6700-410	+ 6700-412	+ 6900-410	+ 6900-412
	& addtl. charge	+ 0,-	+ 0,-	+ 0,-	+ 0,-

Dimensions and panel material

Card-index cabinets, 600 mm deep

For **DIN A6 index cards**, drawers fully extendable, also for **microfilm jackets/microfiches**, incl. 7 mm-thick steel top cover



	Depth: 600	Height	698	998	1298	698
		Width	440	440	440	800
		Interior dimensions, HxWxD	130 x 155x518	130 x 155 x 518	130 x 155 x 518	130 x 155 x 518
		Rows	2-row	2-row	2-row	4-row
		Drawers	4 x 3 HU	6 x 3 HU	8 x 3 HU	4 x 3 HU
		For index cards	DIN A6 landscape	DIN A6 landscape	DIN A6 landscape	DIN A6 landscape
		Order no.	146275-422	146245-622	146225-822	146273-424
		Price	1.315,-	1.522,-	1.825,-	1.685,-

	Optional:				
	& order no.	+ 6400-410	+ 6400-411	+ 6400-412	+ 6900-410
	& addtl. charge	+ 0,-	+ 0,-	+ 0,-	+ 0,-

*Cabinet heights incl. MCPB tops + 18 mm in each case

→ **Body and panel color (for steel panels)**

Color concept → p. 48

→ **Panel/top decor (wood decor panels)**

Color concept → p. 50



Order no. 146224-622



Order no. 146223-824



998

1298

800

800

130 x 155 x 518

130 x 155 x 518

4-row

4-row

6 x 3 HU

8 x 3 HU

DIN A6 landscape

DIN A6 landscape

146243-624

146223-824

2.515,-

3.047,-

+ 6900-411

+ 6900-412

+ 0,-

+ 0,-

+ Tops covers*

MCPB (wood decor) instead of steel top → p. 430

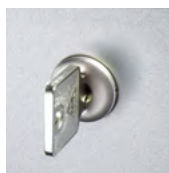

+ Accessories

Central locking system with exchangeable cylinder → p. 430

Compatible with many other C + P furniture items. Also ideal for subsequent organization of locking groups.

! All dimensions in mm, and all prices in Euros

Asisto

Drawer cabinets with special fittings, 600 mm.

Dimensions and panel material

Drawers fully extendable, suitable for **CDs/DVDs** in W 142xD 10xH 125 mm format (jewel case), or W 142xD 5xH 125 mm (slim case), incl. 7 mm-thick steel top cover



Interior fittings for CDs/DVDs in jewel case



Depth: 600	Height	698	1298
	Width	800	800
	Interior dimensions, HxWxD	185 x 154 x 514	185 x 154 x 514
	Rows	4-row	4-row
	Drawers	3 x 4 HU	6 x 4 HU
	Capacity	360 jewel cases or 720 slim cases	720 jewel cases or 1,440 slim cases
Steel panels (standard)	Order no.	146273-324	146223-624
	Price	1.620,-	2.950,-

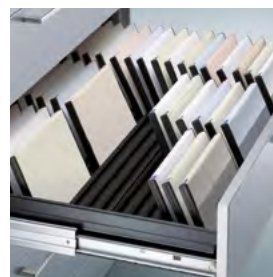

Wood decor panels	Optional:		
	& order no.	+ 6900-410	+ 6900-412
	& addtl. charge	+ 0,-	+ 0,-

Dimensions and panel material

Drawers fully extendable, for **microfilm roll boxes*** of size 16 or 35 mm, incl. 7 mm-thick steel top cover
Box capacity per drawer:
16 mm film roll: 108 pc.
35 mm film roll: 60 pc.



Please specify your project requirements when inquiring about cabinets with interior fittings for DVDs in the W 135xD 14xH 190 mm format!

Depth: 600	Height	998	1298
	Width	800	800
	Interior dimensions, HxWxD	135 x 100 x 485	135 x 100 x 485
	Rows	6-row	6-row
	Drawers	6 x 3 HU	8 x 3 HU
Steel panels (standard)	Order no.	146243-600	146223-800
	Price	3.159,-	3.852,-

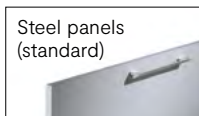

Tray for microfilm roll boxes

Wood decor panels	Optional:		
	& order no.	+ 6900-411	+ 6900-412
	& addtl. charge	+ 0,-	+ 0,-

*Drawer cabinets for jackets/microfiches of size DIN A6, see p. 426/427

→ **Body and panel color (for steel panels)**

Color concept → p. 48

→ **Panel/top decor (wood decor panels)**

Color concept → p. 50



Company

Color concept

Changing room & wardrobe

Workshop & factory

Office & archive

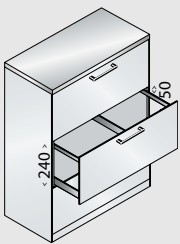

Our interior dimension specifications generally indicate **the usable dimensions** (e.g. from the suspension point of the DIN A4 size suspension file to the next lower panel or drawer bottom).

The usable dimensions from the suspension point to the next **higher** panel are indicated in the drawing on the left.

1 HU = 50 mm

MCPB = Melamine coated particle board

Cabinet heights incl. MCPB top + 18 mm in each case

⊕ **Tops covers***

MCPB (wood decor) instead of steel top → p. 430

Asisto

Accessories for drawer and filing cabinets.

For 435 mm-deep cabinets

Card-index dividers, single

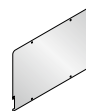

	For DIN A5 landscape index cards	For DIN A4 landscape index cards
Panel height	4 HU	6 HU
Order no.	146000-750	146000-740
Price	11,-	13,-

Alternative top covers

As solid-core/HPL top, instead of the MCPB top

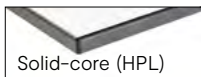

	800	1200
For cabinet width	800	1200
Depth	435	435
Thickness	13	13
Order no.	140003-130	140001-130
& addtl. charge	114,-	151,-

Dividers



	Vertical fixed link For reducing the track width of the hanging frame	Index row plates 1 set (2 pc.), suitable for all models with full drawer bottoms
Length	330	312
Order no.	146000-707	146000-706
Price	19,-	19,-

For 435 and 600 mm-deep cabinets

Label holder

Made of plastic, per piece



	Standard For supplementing the supplied inscription fields (1 per drawer as standard). Color black, incl. label and transparent cover	Comfort As an alternative to additional drawer labeling. Color black, incl. label and transparent cover	
Version	Self-adhesive	Self-adhesive	Magnetic
H x W x D	26 x 76 x 4	39 x 114 x 5	39 x 114 x 5
Window, H x W	17 x 67	30 x 105	30 x 105
Order no.	6103-13	6103-11	6103-12
Price	6,-	15,-	15,-

Exchangeable lock cylinder

With 2 keys, nickel-plated



Single/ spare key

Per pc.

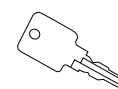

Order no.	2025-02	Order no.	0005-10
Price	15,-	Price	19,-

For 600 mm-deep cabinets

Card-index dividers, single

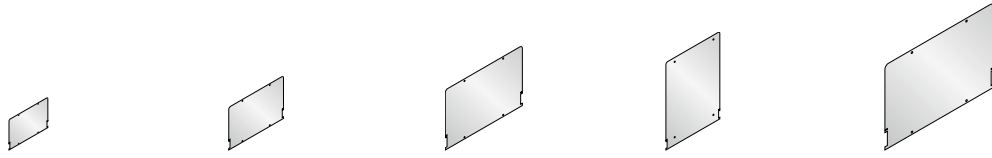

	For DIN A6 landscape index cards	For DIN A5 landscape index cards	For DIN A4 landscape index cards	For DIN A4 portrait index cards	For DIN A3 landscape index cards
Panel height	3 HU	4 HU	6 HU	8 HU	8 HU
Order no.	6496-10	6495-10	6494-10	6494-20	6493-10
Price	11,-	11,-	12,-	14,-	23,-

Alternative MCPB tops

Instead of the 7 mm-thick steel top cover

Width	440	562	800
Depth	600	600	600
Thickness	25	25	25
Order no.	64011-000	67011-000	69011-000
& addtl. charge	79,-	96,-	112,-

Underframes

150 mm high, steel tube, adjustable level. Black gray RAL 7021, other colors on request



Height	150	150	150
Width	440	562	800
Order no.	146200-700	146200-701	146200-702
Price	117,-	131,-	150,-

Soft-stop

For an even softer self-closing system

Version	Per drawer
Order no.	146000-705
& addtl. charge	27,-



Dividers



	Vertical fixed link For reducing the track width of the hanging frame	Index row plates 1 set (2 pc.), suitable for all models with full drawer bottoms
Length	520	527
Order no.	146200-710	6492-00
Price	19,-	23,-

HD rail guide (heavy duty)

For an even higher load capacity

Version	Per drawer	Per drawer incl. soft-stop
Order no.	146000-704	146000-703
& addtl. charge	21,-	48,-



HPL = High-pressure laminate

7100 and 7200 series Multi-drawer cabinets.

Multi-drawer cabinets from C+P know how to inspire. They can be used for just about any desired custom solution, not least thanks to their stepped horizontal and vertical dividers. Only available from C+P.

The cabinet with 10 drawers in one and the same body is another specialty from C+P, just like the trouble-free space-saving storage of up to 15 drawers (per cabinet with a height of 760 and 420 mm)—also on base and with MCPB top on request.





Company

Color concept

Changing room & wardrobe

Workshop & factory

Office & archive

For every application.



For watches (with C+P foam rubber mat)



For coins



For sample collections (with C+P dividers)



For office supplies (with C+P dividers)



For miniatures



For screw/mounting accessories



For collections (with C+P aluminum dividers)

7100 and 7200 series

Multi-drawer cabinets.

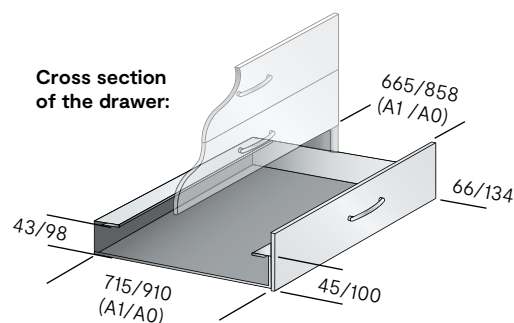

Features of the multi-drawer cabinets of the 7000 series:

The universal drawer cabinets for everything flat,

e.g. drawings, plans, pictures, prints, graphics, collections, medication, small parts and lots more.

- + Sturdy steel construction with overlay drawer fronts and high-quality enamel coating
- + Many combination options thanks to optional base and top covers
- + With sliders for floor protection as standard
- + Elegant and ergonomic bow-shaped handles, matt nickel-plated
- + Central locking system with 2 keys (cylinder lock with exchangeable cylinder)
- + Drawer with self-closing system, fully (DIN A1) or 4/5 (DIN A0) extendable, with anti-tilt mechanism
- + All drawers with pressure device at the front and with cover strip at the back
- + Load capacity per drawer: 40 kg
- + Drawer bottoms are stepped and can be divided, therefore suitable for different applications
- + Available in two sizes (DIN A1 and DIN A0) and two cabinet heights with different drawer configurations
- + Per drawer: 1 transparent label holder with white label as standard

Explanation of the interior dimensions:

Standard version

- 45 mm = Height of the drawer **pan**
- 43 mm = Internal height of the drawer **pan**
- 66/134 mm = Exterior panel height (regular/double panel height)
- 55/120 mm = Internal height of the drawer (regular/double panel height)

Version with high drawer pan and double panel height

(addtl. charge for model 7000-80, see bottom of Page 436)

- 100 mm = Height of the drawer **pan**
- 98 mm = Internal height of the drawer **pan**
- 134 mm = Exterior panel height
- 120 mm = Internal height of the drawer

C+P multi-drawer cabinets in an archive on a customer's rolling shelving system





Order no. 7100-000 & 7101-000
& 7105-000 (top cover)
& 7103-000 (base)



Order no. 7101-000
& 7105-000 (top cover)
& 7103-000 (base)

Dimensions and version

7100 series for sizes up to **DIN A1**,
central locking,
with **fully** extendable drawers



Depth: 765	Height	420	420	760	760	760
	Width	1100	1100	1100	1100	1100
	Drawer interior dimensions, HxWxD	45/55 x 1005 x 710	45/55/120 x 1005 x 710	45/55 x 1005 x 710	45/120 x 1005 x 710	45/55/120 x 1005 x 710
	Description	5 drawers with regular panel height	3 drawers, 1 with regular panel height, 2 with double height	10 drawers with regular panel height	5 drawers with double panel height	8 drawers, 6 with regular panel height, 2 with double height
	Order no.	7100-000	7100-100	7101-000	7101-100	7101-200
	Price	1.459,-	1.194,-	2.418,-	1.700,-	2.131,-

7200 series for sizes up to **DIN A0**,
central locking,
with **4/5** extendable drawers



Depth: 960	Height	420	420	760	760	760
	Width	1350	1350	1350	1350	1350
	Drawer interior dimensions, HxWxD	45/55 x 1255 x 905	45/55/120 x 1255 x 905	45/55 x 1255 x 905	45/120 x 1255 x 905	45/55/120 x 1255 x 905
	Description	5 drawers with regular panel height	3 drawers, 1 with regular panel height, 2 with double height	10 drawers with regular panel height	5 drawers with double panel height	8 drawers, 6 with regular panel height, 2 with double height
	Order no.	7200-000	7200-100	7201-000	7201-100	7201-200
	Price	1.582,-	1.229,-	2.821,-	1.864,-	2.438,-

→ **Body and frame color**

Color concept → p. 48

+ **Accessories**

Selection → p. 436

7100 and 7200 series

Accessories for multi-drawer cabinets.

Top covers, bases and underframes

For 7100 series,
DIN A1 drawers

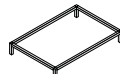
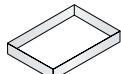
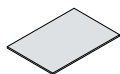

MCPB top
Approx. 25 mm thick
(please specify decor,
for decor overview, see
page 52)

Base
For compartment with
drawers, grips into
the cabinet bottom
all the way around,
recessed approx. 15 mm
in front, please specify color

Underframe
Made of square tube
without intermediate shelf,
please specify color

Underframe
Made of square tube
with an
intermediate shelf,
please specify color

Dimensions, H x W x D	25 x 1100 x 765
Order no.	7105-000
Price	159,-

Dimensions, H x W x D	100 x 1100 x 750
Order no.	7103-000
Price	125,-

Dimensions, H x W x D	150 x 1100 x 750
Order no.	7106-000
Price	217,-

Dimensions, H x W x D	445 x 1100 x 750
Order no.	7104-000
Price	292,-

For 7200 series,
DIN A0 drawers

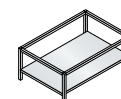
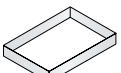
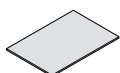

MCPB top
Approx. 25 mm thick
(please specify decor,
for decor overview,
see Page 52)

Base
For compartment with
drawers, grips into
the cabinet bottom
all the way around,
recessed approx. 15 mm
in front, please specify color

Underframe
Made of square tube
without intermediate shelf,
please specify color

Underframe
Made of square tube
with an
intermediate shelf,
please specify color

Dimensions, H x W x D	25 x 1350 x 960
Order no.	7205-000
Price	210,-

Dimensions, H x W x D	100 x 1350 x 945
Order no.	7203-000
Price	145,-

Dimensions, H x W x D	150 x 1350 x 945
Order no.	7206-000
Price	274,-

Dimensions, H x W x D	445 x 1350 x 945
Order no.	7204-000
Price	369,-

Compartment dividers

For DIN A1 drawers



Number of compartments
Maximum compartment
dimensions per divider, W x D
Order no.
Price

2 x DIN A2
620 x 440
0102-00
11,-

4 x DIN A3
500 x 340
0104-00
30,-

8 x DIN A4
245 x 340
0108-00
48,-

Order no. 0108-00

Compartment dividers

For DIN A0 drawers

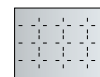
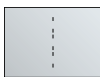

Number of compartments
Maximum compartment
dimensions per divider, W x D
Order no.
Price

2 x DIN A1
620 x 890
0202-00
15,-

4 x DIN A2
620 x 440
0204-00
29,-

8 x DIN A3
305 x 440
0208-00
57,-

16 x DIN A4
305 x 220
0216-00
95,-

Drawer pans

Height of 100 mm* for drawers with double panel
height in models 7100/7200-100 and 7101/7201-
100/200. Additional charge per drawer (for explanation
of the interior dimensions, see page 434)

Order no.	7000-80
Price	36,-

Compartment dividers

Single, max. fill height
up to pressure device:
approx. 4 cm

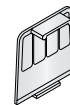
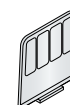

Application	Used vertically , without pressure device	Used horizontally , with pressure device
Order no.	7000-10	7000-20
Price	2,-	2,-

*Longer delivery time possible.

Drawer dividers

Made of sturdy plastic, color gray, with approx. 20 mm steps

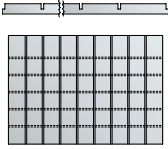
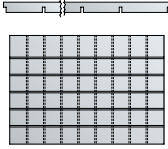

	Vertical divider For insertion into horizontal divider	Horizontal divider For insertion into vertical divider
		
Dimensions, HxWxD	40x5x702	40x1003x5
Order no.	7100-704	7100-705
Price	16,-	21,-



Order no. 7100-704 & 7100-705

Drawer tidies

Plastic boxes for small parts

	For mod. 7100/7101	With 7 vertical aluminum rails, 5 transparent horizontal dividers per rail, each row steplessly adjustable , for quick and flexible configuration
		
For drawer	DIN A1	DIN A1
Description	20 boxes each: 198 x 99 mm 99 x 99 mm 49 x 49 mm 10 boxes: 99 x 49 mm All 40 mm high	7 horizontal rows 6 x 145 mm row width 1 x 90 mm row width Height: 35 mm
Order no.	7100-5051	7100-709
Price	203,-	470,-





Order no. 7100-5051



Order no. 7100-709

Foam rubber mat

3 mm thick

		
For drawer	DIN A1	DIN A0
Dimensions, WxD	1005 x 710	1255 x 905
Order no.	7100-706	7200-706
Price	48,-	79,-



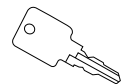

Single/spare key



Order no.	0005-00
Price	19,-

Label holder

Made of plastic, per piece

	Label holder Transparent, incl. white label (1 pc. per drawer as standard)		Standard For supplementation of the included inscription fields. Color black, incl. label and transparent cover		Comfort As an alternative to additional drawer labeling. Color black, incl. label and transparent cover	
						
Version	Self-adhesive	Self-adhesive	Self-adhesive	Self-adhesive	Magnetic	
HxWxD	32 x 100 x 2	26 x 76 x 4	26 x 76 x 4	39 x 114 x 5	39 x 114 x 5	
Window, H x W	26 x 98	17 x 67	17 x 67	30 x 105	30 x 105	
Order no.	6103-10	6103-13	6103-13	6103-11	6103-12	
Price	4,-	6,-	6,-	15,-	15,-	

Office furniture & accessories



Counters and lounge furniture

The right furniture for THE NEW WORLD OF WORKING

The way we work is changing. Coziness and an atmosphere of well-being in the office are playing an increasingly important role. More and more, the office of today is becoming a living room where lounge and meeting furniture are supplementing the classic desk and workstation.

What you'll find in this section:

- + Customized solutions for reception counters
- + Basic standing tables as a "moving" meeting point
- + Asisto lounge furniture as a place to retreat to for concentrated work and informal meetings

Tables

The contemporary work and meeting solutions

Whether it's ergonomic sit/stand workstations or smart solutions for meetings: Contemporary office tables of today have to offer more than function and efficiency. Like tables from C+P, which come in an attractive selection of colors and decors, among other things.

What you'll find in this section:

- + Electric height adjustment Asisto sit/stand tables
- + Asisto occasional tables with fixed or adjustable height
- + Asisto folding tables as a mobile, nestable version
- + Basic cafeteria tables and folding tables



Around the desk

Welcome additions for working better

The difference is in the details! The right parameters in the work environment have a major influence on well-being and motivation—and therefore on the results of work. Whether it's the addition of thinking lighting, the acquisition of privacy sections or optimization of the monitor position: These investments always pay off.

What you'll find in this section:

- + Workstation dividers
- + Asisto light with active brightness control
- + Asisto monitor holders



Chairs and stools

The ergonomic swivel and task chairs

Healthy and pleasant sitting isn't just a decisive factor at the workplace. Chairs which not only look good, but also enable comfortable sitting, are also needed at meetings & seminars, for visits and for meetings at the office counter.

What you'll find in this section:

- + Basic workstation swivel chair
- + Asisto office swivel chair with 3D knitted membrane
- + Basic and Asisto visitor chairs
- + Basic and Asisto stackable chairs
- + Bar stools



Cabinets, pedestals and caddies

The experts for storage space and flexible catering near the workstation

Everything at hand and in the right place in the right pull-out cabinet or pedestal: Naturally, made of steel with long-lasting and convenient pull-outs, nearly unlimited color variety and an impressive appearance and technology. This also applies for C+P fridge caddies, which provide perfect service in the conference area.

What you'll find in this section:

- + Asisto pull-out cabinets at standing and sitting height
- + Asisto mobile pedestals
- + Asisto fridge caddies

Reception counter

Design meets function and expression.

The reception counter is the first piece of furniture at your company that people see. That's why it's all the more important that you design this area in line with your tastes and your company's image. C+P has an extensive portfolio:

- + Reception solutions for every need
- + Stylish business cards for the entrance area of any company
- + Also for clinics, institutes, public facilities and lots more
- + Available in a wide variety of different surfaces, colors and versions
- + Made of sturdy and high-quality materials

Whether it's light or dark, modern or timeless: The choice is yours, and you'll be delighted at how your new counter influences the effect of the space and creates a positive impression.

Ask us about your customized reception counter—we look forward to handling your task!





Company

Color concept

Changing room & wardrobe

Workshop & factory

Office & archive

Basic

Standing tables.

The Basic standing table keeps the body in motion and the thoughts flowing.

Basic—keeps the body in motion and the thoughts flowing. Meetings held standing are generally shorter and thereby promote work efficiency.

For short meetings, an exchange of ideas, brainstorming, collecting information or a coffee break, the Basic standing table makes communication zones possible in large offices.

- + Sides and tabletop are always made of sturdy 38 mm-thick panels
- + All surfaces are coated with high-quality, durable HPL
- + Sides each feature 2 floor-compensating adjustable feet for easy leveling
- + Connection between side and tabletop with 5 mm shadow gap in silver
- + Delivered disassembled with easy assembly instructions
- + **The decor of the work top is your choice, and the side & connection crossbar are always diamond white**



Dimensions and versions

Size	1.600 x 800	2.000 x 800	2.400 x 800
Height	1.100	1.100	1.100
For no. of people	4 people	6 people	8 people
Order no. (for work top decor diamond white)	99001-0025-183	99001-0026-183	99001-0027-183
Price	2.140,-	2.410,-	2.680,-
Surfaces	HPL surface	HPL surface	HPL surface

Top decor of work top	Decor no.
Diamond white	-183
Light gray	-002
Royal maple	-053
Light acacia	-062
Basalt oak	-189
Light concrete	-185

The specified product order no. includes the first work top decor of the decor chart at the end (diamond white, decor no. -183). All other work top decors are available at no additional charge—simply change the decor no. at the end of the product order no.



Company

Color concept

Changing room & wardrobe

Workshop & factory

Office & archive



Light acacia



Concrete



Basalt oak



Royal maple

Asisto Lounge.

Features of the Asisto lounge sofas:

- + Ideal supplement for the reception, lounge or central zone
- + Currently available as a sofa and highback in 3 widths
- + 5 materials from the FENICE collection can be combined

The way we work is changing. On the one hand, day-to-day work is getting faster all the time and requirements on each individual are increasing. On the other hand, coziness and an atmosphere of well-being play an important role at the office. Relaxation and the ability to retreat are utilized to develop new energies and creativity.

More and more, the office of today is becoming a living room where lounge and meeting furniture are supplementing the classic desk and workstation.

The Asisto lounge offers a visual and acoustic space to retreat to for concentrated work.



Dimensions and versions



Model	2-seaters	2-seaters MAX	3-seaters
Version	2-seater sofa with low sides and back	2-seater sofa WIDE with low sides and back	3-seater sofa with low sides and back
Width	1410	1810	2045
Height	870	870	870
Upholstered backrest	Freely selectable and combinable, order no. for upholstered backrest material color light green: 41		
Upholstered seat	Freely selectable and combinable, order no. for upholstered seat material color dark green: -042		
Order no.	99001-0141-042	99001-0241-042	99001-0341-042
Price	2.450,-	2.700,-	3.230,-

- + All lounge furniture features sturdy powder-coated steel tube framing on round plastic sliders, black
- + Version always features upholstered sides and back panels
- + Material selection from the FENICE collection, as per the EU Ecolabel
- + One loose back cushion for increased sitting comfort per seat, always in the seat upholstery color
- + Internal structure made of reinforced laminated wood
- + Seat height: 460 mm
- + Other shapes, combinations, materials, versions and electrification options on request



Dimensions and versions



Model	2-seaters	2-seaters MAX	3-seaters
Version	2-seater sofa with high sides and back	2-seater sofa WIDE with high sides and back	3-seater sofa with high sides and back
Width	1410	1810	2045
Height	1310	1310	1310
Upholstered backrest	Freely selectable and combinable, order no. for upholstered backrest material color sand: 52		
Upholstered seat	Freely selectable and combinable, order no. for upholstered seat material color orange: -012		
Order no.	99001-0452-012	99001-0552-012	99001-0652-012
Price	2.790,-	3.230,-	3.460,-

Colors/Materials (see number code)

FENICE material	Upholstered backrest	Upholstered seat
Orange	12	-012
Light green	41	-041
Dark green	42	-042
Sand	52	-052
Red	21	-021



Number code in example
99001-0421-021
(see figure to left)

Basic number:
99001-0421-021

Upholstered backrest:
99001-0421-021

Upholstered seat:
99001-0421-021

+ Other material colors and combinations on request

Asisto

Sit/stand tables.

The affordable sit/stand tables for diverse office tasks

- + T-foot frame made of sturdy steel rectangular tubing
- + **Electric** height adjustment (40 mm/sec), with enhanced collision protection as per DIN
- + Double telescopic extension with sit/stand height of **625 – 1,285 mm**
- + Table load capacity up to 100 kg
- + Available in 3 attractive frame colors
- + Tabletop in MCPB, optionally with high-quality Synchro surface
- + Delivered fully assembled, frame collapsible for easier transport and storage
- + Economical and ergonomic sit/stand table promotes movement, reduces downtime costs and motivates employees

Dimensions and versions

Rectangular bottom frame, electric height adjustment from 625 – 1,285



Height: 625 – 1,285 Depth: 800	Width	1600	1800	2000
MCPB top, 25 mm (standard)	Order no.	540490-1.1	540490-1.10	540490-1.8
	Price	1.159,-	1.192,-	1.229,-
Synchro decor, 25 mm	& order no.	+ 540708-1.1	+ 540708-1.10	+ 540708-1.8
	& addtl. charge	+ 70,-	+ 70,-	+ 70,-

Frame/runner color

- Traffic white
- White aluminum
- Black gray metallic

+ Exclusive height adjustment
With memory control,
height indicator and 2x USB

& order no.	On request
& addtl. charge	On request



+ Cable aperture sockets
80 mm dia., installed in
tabletop at factory

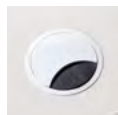

Installation location	Version	White plastic	Black plastic	Metal
Left	Order no.	540700-721L	540700-722L	540700-707L
	Price	36,-	36,-	50,-
Center	Order no.	540700-721M	540700-722M	540700-707M
	Price	36,-	36,-	50,-
Right	Order no.	540700-721R	540700-722R	540700-707R
	Price	36,-	36,-	50,-



- + **Sheet metal cable duct**
Folds down in front and back, lockable at 2 heights, hole in center for triple socket

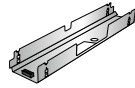

For desk width	1600	1800	2000
Order no.	540700-7084	540700-7085	540700-7086
Price	49,-	56,-	63,-

- + **Sockets and wiring**



Version	Triple socket strip	GST-18 supply line, 3 m	GST-18 extension, 3 m
Order no.	540700-713	540700-715	540700-717
Price	36,-	17,-	25,-

- + **Netboxes with various power, data and communication connections on request**



- **Top decor**

Color concept → p. 52







- + **Other accessories on request**

Asisto

Occasional tables.

The affordable meeting tables for diverse office tasks:

- + Sturdy foot frame made of thick-walled steel tube
- + Fixed heights of 720 and 1,100 mm
- + Or with height adjustment of 700 – 1,135 mm, depending on the lifting technology
- + Available in 3 attractive frame colors
- + Tabletops in MCPB
- + Delivered fully assembled

Tabletop decors	Decor no.
 Diamond white	-183
 Light gray	-002
 Royal maple	-053
 Light acacia	-062
 Basalt oak	-189
 Concrete	-185

The specified product order no. includes the first decor of the decor chart at the end (diamond white, decor no. -183). All other decors are available at no additional charge—simply change the decor no. at the end of the product order no.

Dimensions and version

Meeting table SQUARE
25 mm tabletop
Base plate and foot tube
Square



Height	720	1.100	700 - 1.135
Size	800x800	800x800	800x800
Version	Fixed height	Fixed height	Lifting technology

Frame color 	White aluminum		
Order no. (for diamond white decor)	99001-0001-183	99001-0004-183	99001-0007-183
Price	660,-	710,-	1.160,-

Frame color 	Traffic white		
Order no. (for diamond white decor)	99001-0002-183	99001-0005-183	99001-0008-183
Price	660,-	710,-	1.160,-



Frame color 	Black gray metallic		
Order no. (for diamond white decor)	99001-0003-183	99001-0006-183	99001-0009-183
Price	660,-	710,-	1.160,-



Dimensions and version

Meeting table ROUND
25 mm tabletop
Base plate and foot tube, round



Height	720	1.100	700 - 1.135
Size	Ø 800	Ø 800	Ø 800
Version	Fixed height	Fixed height	Lifting technology
Frame color 	White aluminum		
Order no. (for diamond white decor)	99001-0010-183	99001-0013-183	99001-0016-183
Price	700,-	770,-	1.190,-
Frame color 	Traffic white		
Order no. (for diamond white decor)	99001-0011-183	99001-0014-183	99001-0017-183
Price	700,-	770,-	1.190,-
Frame color 	Black gray metallic		
Order no. (for diamond white decor)	99001-0012-183	99001-0015-183	99001-0018-183
Price	700,-	770,-	1.190,-

Asisto

Mobile folding table.

The flexible solution for seminars and meetings:

- + Easy to operate folding mechanism with a bar under the front edge of the tabletop for one-handed operation
- + Foldable table frame, for space-saving nesting
- + Frame color: Silver aluminum
- + 2 table top grid sizes in 6 standard decors each
- + 720 mm high
- + MCPB tabletops, with standard edge band or rounded with rubber edge for better impact resistance
- + Delivered fully assembled

Dimensions and version

With edge band

MCPB tabletop, rectangular
Table height: 720, on casters, foldable, silver aluminum frame



Size	1400 x 700	1600 x 800
Height	720	720
Version	Foldable/Nestable	Foldable/Nestable
Table top edge	Edge bands	Edge bands
Order no. (for diamond white decor)	99001-0019-183	99001-0020-183
Price	1.080,-	1.140,-

With rubber edge

MCPB tabletop, rounded
Table height: 720 mm, on casters, foldable, silver aluminum frame



Size	1400 x 700	1600 x 800
Height	720	720
Version	Foldable/Nestable	Foldable/Nestable
Table top edge	With rubber	With rubber
Order no. (for diamond white decor)	99001-0021-183	99001-0022-183
Price	1.290,-	1.360,-



→ Top decor

Color concept → p. 52









Accessories

Modesty panel

For easy assembly

Width	1400	1.600
Size	1040 x 250	1240 x 250
Version	Foldable/Nestable	Foldable/Nestable
Order no. (for diamond white decor)	99001-0023-183	99001-0024-183
Price	180,-	190,-

Tabletop decors	Decor no.
 Diamond white	-183
 Light gray	-002
 Royal maple	-053
 Light acacia	-062
 Basalt oak	-189
 Concrete	-185

The specified product order no. includes the first decor of the decor chart at the end (diamond white, decor no. -183). All other decors are available at no additional charge—simply change the decor no. at the end of the product order no.

Basic

Cafeteria tables.

4-foot tables:

Multi-purpose tables from C + P meet a variety of needs. They can be used as meeting tables, as storage space and as workspace. The steel frame of the multi-purpose tables isn't just very robust, but has a timeless and minimalist effect as well:

- + Tabletop: 25 mm thick with 3 mm edge band, light gray decor
- + Steel underframe with 30x30 mm square legs, light gray RAL 7035
- + Level adjustable by 25 mm
- + Load capacity of max. 100 kg with evenly distributed load
- + Tables are delivered disassembled, but are easy to assemble!
- + Dimensions, (HxWxD): 750 x 1,200 – 1,800x800 mm

Dimensions and version

Steel tube frame RAL 7035, light gray MCPB tabletop



Size	1.200 x 800	1.600 x 800	1.800 x 800
Height	750	750	750
Version	Disassembled	Disassembled	Disassembled
Order no.	99699-00001	99699-00002	99699-00003
Price	143,-	174,-	205,-

Folding tables:

- + Folding table frame made of chrome-plated round tube with folding mechanism, stackable
- + Table height: 750 mm (folded only 125 mm)
- + Durable, melamine-coated tabletop (25 mm thick) with edge band

Dimensions and versions

Chrome-plated round-tube frame, 30 mm dia., quick setup thanks to special folding mechanism, stackable for space-saving storage,

height: 750 mm (folded: 125 mm)

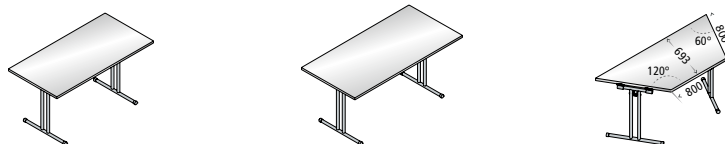

 MCPB, 25 mm (standard)	Width	1400	1600	1600/800
	Depth	700	800	800/693
	Order no.	51022-1.9	51022-1.1	51022-2.10
	Price	546,-	560,-	560,-

→ **Top decor**
(for folding tables only)

Color concept → p. 52



Company

Color concept

Changing room & wardrobe



Workshop & factory

Office & archive

Workstation dividers

Features of the privacy element:

- + Privacy with improved direct speech acoustics
- + Table-back element, rigid
- + Height: 800 mm, 200 mm projection under top edge of tabletop
- + Planked support panel/honeycomb panel, corner radius: R40, depth: 25 mm
- + Attached with spacing of 10 mm to tabletop
- + Lucia fabric cover (colors as per LUCIA fabric card) featuring quilting seams
- + Wall thickness: approx. 28 mm
- + Incl. holder set for tabletop clamping (for 10 mm spacing)

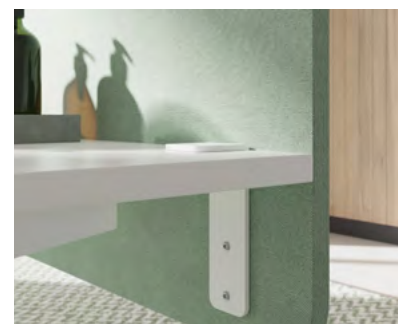

Dimensions and versions











Width	1600	1800	2000
Height	800	800	800
Surfaces	LUCIA fabric	LUCIA fabric	LUCIA fabric
Holder color	White aluminum	White aluminum	White aluminum
Order no. (for fabric color rum)	99001-0043-086	99001-0044-086	99001-0045-086
Holder color	Traffic white	Traffic white	Traffic white
Order no. (for fabric color rum)	99001-0046-086	99001-0047-086	99001-0048-086
Holder color	Black gray metallic	Black gray metallic	Black gray metallic
Order no. (for fabric color rum)	99001-0049-086	99001-0050-086	99001-0051-086
Price	500,-	530,-	550,-



The stand-up wall system offers ideal privacy and fits into a harmonious overall picture thanks to its lightness. With its rounded corners the stand-up wall exhibits modern zeitgeist. It's available as a table back element, where the cable duct and cable channel are covered by the projection. A host of color variants are available for selection.

+ Additional versions, surfaces and dimensions on request

LUCIA fabric colors	Fabric no.
 Rum (light gray)	-086
 Havana (black)	-009
 Paseo (dark gray)	-019
 Sombrero (dark olive)	-046
 Solano (yellow)	-088
 Apple (light green)	-096
 Madura (bright green)	-056
 Marianna (light blue)	-057

Composition of LUCIA fabric:
 100% recycled polyester
 Dyes do not contain heavy metals
 Environmentally friendly
 In accordance with EU Ecolabel certificate
 In accordance with OEKO-TEX® Standard 100 certificate
 Made of 100% recycled polyester

The specified product order no. contains the first color of the fabric chart (rum, fabric no. -086) at the end. All other colors are available at no additional charge—simply change the fabric no. at the end of the product order no.

Asisto Light.

Features of ASISTO floor lamp SOLO:

- + LED floor lamp, single illumination, direct/indirect
- + With LRC (Luminosity Range Control, see description below)
- + Presence detector for maximum energy efficiency
- + Color temperature: 4,000 kelvin neutral white (daylight)
- + Protection type IP20
- + Lamp head rotatable 90° and telescopic
- + 24 volts (with 230-volt connection cable)/55 watts, standby: 0.5 watts
- + 3 colors



Dimensions and versions

Color	Traffic white	Silver aluminum	Black gray
Values	4,000 kelvin/55 watts	4,000 kelvin/55 watts	4,000 kelvin/55 watts
Function	LRC & presence detector	LRC & presence detector	LRC & presence detector
Order no.	99001-0040-014	99001-0040-010	99001-0040-016
Price	1.900,-	1.900,-	1.900,-

The smart lamp system of the Asisto series complements the ergonomic workstation.

Newly developed active Luminosity Range Control ensures that the illumination angle and the illumination values are automatically adapted to the working height of sit/stand tables. Customized light scenes set by the user are retained at each table height.

LEDs of the lamp head are dimmed depending on the table height. This means that your eyes don't have to adjust to changing lighting conditions, but rather that the lighting conditions adjust to your eyes.

The light shines both up (indirect) and down. Dimmable adjustment is made using the display

A spotlight function for continuous constant light is integrated and can be selected using the operating panel



Company

Color concept

Changing room & wardrobe

Workshop & factory

Office & archive

Asisto

Monitor holders.

Features of the Asisto monitor arm:

- + Single- or double-screen solution
- + Up to 27" in size and 7 kg in weight
- + Attachment standard VESA 75/100, incl. quick release
- + With gas lift and horizontal arm element
- + Toolless monitor changing
- + Sturdy, yet flat, pivot joint for nearly unlimited freedom of movement
- + Flexible attachment options thanks to 3-in-1 table attachment
- + Color: white, silver or black
- + Delivered disassembled for easy assembly



Dimensions and versions

Type	SINGLE	SINGLE	SINGLE
Max. monitor size	27" / 7 kg	27" / 7 kg	27" / 7 kg
Range in mm	457	457	457
Color	White	Silver	Black
Order no.	99001-0041-023	99001-0041-025	99001-0041-026
Price	450,-	450,-	450,-



Type	DUO	DUO	DUO
Max. monitor size	2 x 27" / 7 kg	2 x 27" / 7 kg	2 x 27" / 7 kg
Range in mm	333	333	333
Color	White	Silver	Black
Order no.	99001-0042-023	99001-0042-025	99001-0042-026
Price	810,-	810,-	810,-



Smart cable duct

All connecting cables are routed neatly and protected under the unobtrusive cover. The powerful gas lift element for top-notch ease of operation is also found here.



Quick release

Monitors can easily be inserted or changed by one person by hand without any tools at all. The holder fits all common monitors with the 75 x 75 and 100 x 100 attachment standard.



Sturdy joint technology

The high-quality pivot joint is considerably flatter than a conventional ball joint, so it offers nearly unlimited freedom of movement in every turn and tilt direction. Large monitors can also be effortlessly handled and remain securely in the set position.



3-in-1 table attachment

The standard attachment element can be conveniently secured from above and covers three mounting types in one: clamp, cable opening and drill hole attachment. It offers optimal flexibility should the attachment type be changed.

Basic

Workstation swivel chair.

Features of the Basic office workstation chair:

- + Office swivel chair with load-dependent braked casters
- + Attractively shaped plastic base in black
- + Integrated synchronous mechanism for seat and backrest, 4 locking positions
- + Body weight adjustment in the mechanism between 45 and 120 kg
- + Functional seat depth adjustment (adjustment range: 50 mm)
- + Backrest with net fabric
- + Armrest height and depth adjustable in 3D
- + Height-adjustable lumbar support



Dimensions and versions

	Fabric	Xtreme black
	Model	With 3D armrest
	Chair base	Black
	Height	1025–1155
	Seat height	418–539
	Width without/with armrests	480/635
	Depth	475
With soft casters	Order no.	99001-0030-002
	Price	660,-
With hard casters	Order no.	99001-0030-001
	Price	660,-

Xtreme is a modern fabric made of up to 100% recycled polyester. This prevents waste and conserves raw materials. Thanks to its stretch characteristics, flame-resistance, long service life and anti-pilling properties, Xtreme is ideal for use on chairs.

Composition

100% recycled flame-resistant polyester

Dyes do not contain heavy metals

Environmentally friendly

Made of 100% recycled polyester

In accordance with EU Ecolabel certificate

**Synchronous mechanism**

Seat and back tilt in sync. Sync ratio of backrest to seat is 2.4:1. Force of 45 to 129 kg using side level in just 2 turns. The mechanism has 4 locking positions.

**3D armrest**

Polyamide armrests with fiberglass and SoftTouch PU coating. Vertically adjustable, with depth-adjustable and swiveling support

**Lumbar**

Vertically adjustable lumbar support with flexible slats

**Soft casters**

(for hard floors)

**Hard casters**

(for soft floors)

Asisto

Office swivel chair.

Features of the Asisto office swivel chair:

- + Dynamic synchronous mechanism
- + 5 plastic colors for back, mechanism cladding, armrests and base
- + Colorful overall design available in 5 colors
- + Seat always made of special molded PU foam with opaque knit fabric in 5 colors
- + 2D armrests, black
- + 2 back variants:
 - 3D knit back, transparent in 5 colors (net)
 - 3D knit back, opaque in 5 colors (comfort)
- + Version always features integrated lumbar support
- + 100 % recyclable due to modular principle
- + Made in Germany
- + Certified with the highest European sustainability certification level 3



Dimensions and versions

	Color	LIGHT GRAY	Black gray
	Model	Office swivel chair	Office swivel chair
	Armrest	2D PP	2D PP
	Frame color/5-star base	3008 light gray	3004 black gray
With seat cover & 3D net back	Order no.	99001-3108-N03	99001-3104-N02
	Price	810,-	810,-
With seat cover & 3D comfort back	Order no.	99001-3108-K03	99001-3104-K02
	Price	830,-	830,-

The 3D knit membrane

This is precisely fit to the backrest and seat. It's various back zones are designed in such a way that the flexible functions of the backrest are optimally supported. In the lumbar area, it features greater tension than in the shoulder area, forming a perfect symbiosis together with the back design for comfortable sitting. The 3D knit membrane also contributes to sustainability.



Company

Color concept

Changing room & wardrobe

Workshop & factory

Office & archive



DARK RED

Office swivel chair

2D PP

3021 dark red

99001-3121-N05

810,-

99001-3121-K05

830,-

DARK GREEN

Office swivel chair

2D PP

3022 dark green

99001-3122-N04

810,-

99001-3122-K04

830,-

BLACK

Office swivel chair

2D PP

3005 black

99001-3105-N01

810,-

99001-3105-K01

830,-

All chairs are outfitted with soft casters for hard floors as standard, indicated by the -31 in the order number. If you change this number to -32, we will supply hard rollers for carpet at no additional charge.







Visitor chairs



Basic visitor chairs:

- + Cantilever chair with armrest, stackable
- + Steel tube frame, 25 mm dia., chrome-plated
- + Perforated backrest made of plastic in 2 colors
- + Upholstered seat with Xtreme fabric

Model	Basic (visitor chair)	
Upholstered seat fabric	Xtreme	
Version	Cantilever chair with armrest, stackable	
Frame	Steel tube, chrome-plated	
Back	Black	Silver gray
Order no. (for Havana fabric, black)	99001-0032-240	99001-0033-240
Price	440,-	440,-

Xtreme fabric colors	Fabric no.
 Havana, black	-240
 Ocean, blue	-210
 Blizzard, gray	-220
 Scuba, navy blue	-226
 Costa, dark blue	-230
 Panama, red	-260
 Padang, black gray	-270

The specified product order no. contains the first color of the fabric chart (Havana, black, fabric no. -240) at the end. All other colors are available at no additional charge—simply change the fabric no. at the end of the product order no.



Asisto visitor chairs:

- + Cantilever chair with armrest, stackable
- + Steel tube frame, powder-coated in 5 colors
- + Attractively shaped perforated backrest made of plastic in 5 colors
- + Upholstered seat with Asisto fabric same as frame color

Model	Asisto (visitor chair)				
Fabric seat upholstery	Asisto fabric				
Version	Cantilever chair with armrest, stackable				
Frame	Steel, powder-coated				
Back	Light gray	Black gray	Red	Green	Black
Order no.	99001-3505-N03	99001-3505-N02	99001-3505-N05	99001-3505-N04	99001-3505-N01
Price	520,-	520,-	520,-	520,-	520,-



Asisto colors

19503 light gray	-N03
19502 black gray	-N02
19505 red	-N05
19504 green	-N04
19501 black	-N01

These colors are already encoded in the specified product order numbers.

Stackable chairs

When chairs need to be set up and put away again quickly and with space in mind, stackable chairs are the right choice:

The all-plastic **Basic** model is the right alternative for anyone with high aesthetic demands and a limited budget.

Should you prefer an appealing steel frame and optional seat upholstery, **Asisto** is the right address.



Model	Basic	Asisto
Seat	PP	Anti-UV PP
Version	Stackable chair	Multi-purpose chair
Frame	Plastic, black	Steel, chrome-plated
Seat shell	Plastic	Plastic
Upholstered seat	-	-
Seat height	461	440
Total height	941	815
Seat width	526	450
Total width	526	540
Total depth	539	580
Order no. (for 1st color in color chart)	99001-0031-803	99001-0034-057
Price	210,-	210,-

Colors	Basic seat shell	Color no.	Asisto seat shell	Color no.
	Olive	-803	White	-057
	White	-800	Red	-051
	Ocher	-801	Black	-056
	Light gray	-802	Gray	-054
	Light blue	-804		
	Pink	-805		
	Dark gray	-806		
	Terracotta	-807		

The specified product order nos. contain the first color of the respective color chart at the end. All other colors are available at no additional charge—simply change the color no. at the end of the product order no.



Stackable chairs with armrests on request



ASISTO faux leather
Anti-UV PP
Multi-purpose chair
Steel, chrome-plated
Black PP
EcoPELLE faux leather
440
815
450
540
580
99001-0034-820
290,-

ASISTO fabric
Anti-UV PP, seat with cover
Multi-purpose chair
Steel, chrome-plated
Black PP
Xtreme fabric (description on Seite 469)
440
815
450
540
580
99001-0035-240
290,-

ASISTO fabric
Anti-UV PP, seat with cover
Multi-purpose chair
Steel, chrome-plated
White PP
Xtreme fabric (description on Seite 469)
440
815
450
540
580
99001-0036-240
290,-

Asisto seat upholstery (faux leather)

■ Black	-820
---------	------

Asisto seat upholstery (fabric)

■ Havana, black	-240
■ Ocean, blue	-210
■ Blizzard, gray	-220
■ Scuba, navy blue	-226
■ Costa, dark blue	-230
■ Panama, red	-260
■ Padang, black gray	-270

Fabric no.

The specified product order nos. contain the first color of the fabric chart at the end. All other colors are available at no additional charge—simply change the fabric no. at the end of the product order no.

Bar stools

In different frame colors, with 4-foot or skid frame, optionally with seat upholstery



Model	Basic 4 Bar	Basic 4 Bar	Basic Bar
Seat	Beech, laminated	Beech, laminated	Oak, laminated
Frame	Steel, chrome-plated, stackable	Steel, chrome-plated, stackable	Steel, black
Seat shell	Beech, white	Beech, natural	Oak, veneered
Upholstered seat	-	-	-
Order no.	99001-0039-000	99001-0039-001	99001-0037-000
Price	280,-	270,-	400,-











Basic Bar
Oak, laminated
Steel, white
Oak, veneered
-
99001-0038-001
400,-

Basic Bar
Oak, laminated with seat upholstery
Steel, black
Oak, veneered
Xtreme fabric
99001-0037-240 (Havana, black)
490,-

Basic Bar
Oak, laminated with seat upholstery
Steel, white
Oak, veneered
Xtreme fabric
99001-0038-260 (Panama, red)
490,-

Seat upholstery fabric colors

Fabric no.

 Havana, black	-240
 Ocean, blue	-210
 Blizzard, gray	-220
 Scuba, navy blue	-226
 Costa, dark blue	-230
 Panama, red	-260
 Padang, black gray	-270

The specified product order nos. contain the specified color of the fabric chart at the end. All other colors are available at no additional charge—simply change the fabric no. at the end of the product order no.

Xtreme is a modern fabric made of up to 100% recycled polyester. This prevents waste and conserves raw materials. Thanks to its stretch characteristics, flame-resistance, long service life and anti-pilling properties, Xtreme is ideal for use on chairs.

Composition

100% recycled flame-resistant polyester

Dyes do not contain heavy metals

Environmentally friendly

Made of 100% recycled polyester

In accordance with EU Ecolabel certificate

Asisto

Pull-out cabinets.

Features of the pull-out cabinets:

- + Body in sturdy steel construction with high-quality enamel coating, fronts made of MCPB (melamine coated particle board) as standard, available in steel (double-walled and insulated)
- + Standard top cover made of MCPB (melamine coated particle board)
- + Slotted shelves in black gray on the inside
1 slot-in binder support in black gray per shelf
- + Cabinet floor also slotted with 1 slot-in binder support
- + 1 open compartment with felt mat above
- + High load capacity of each shelf of 50 kg, adjustable shelves
- + Allows for quick access to personal files when pulled out, standing height cabinet provides visual and acoustic screening and acts as a central contact area for visitors
- + Metal cabinet handle, matt nickel-plated
- + Safety lock with exchangeable cylinder and 2 keys
- + Appealing design and narrow edges
- + Level adjustment as standard, incl. wide front support roll for optimal floor protection
- + Pleasant sound levels thanks to body sound absorption
- + High-quality drawer guide with soft-close



Order no. 148436-00L

On left
Table on right



Order no. 148466-00L
& 148436-704

Pull-out cabinet

Width: 430 | Depth: 800
incl. MCPB top,
25 mm thick, for use on
left or right next to the desk

Standing height

On left or right,
steel body with MCPB front wood decor

Sitting height

On left or right,
steel body with MCPB front wood decor

Height	1259	740
Interior fittings	Basic version with top open compartment with felt mat, 2 adjustable shelves for 3 binder heights, with 1 slot-in binder support each	Basic version with top open compartment with felt mat, 1 adjustable shelf for 1 binder height & extra compartment, with 1 slot-in binder support each
Order no. for left	148436-00L	148466-00L
Order no. for right	148436-00R	148466-00R
Price	1.713,-	1.411,-
<hr/>		
& optional steel front		
Order no.	+ 148436-710	+ 148466-710
& addtl. charge	+ 71,-	+ 57,-
<hr/>		
& alternative top cover as solid-core/HPL top		
Order no.	+ 148436-130	+ 148436-130
& addtl. charge	+ 120,-	+ 120,-

→ Body color

Color concept → p. 48

→ Top decor

Color concept → p. 52



Pedestal on right shown here



Security compartment

Interior dimensions, (HxWxD)	57 x 385 x 307/292
Order no.	148436-704
Price	126,-



Small part trays

Made of plastic,
to be placed on
the felt mat

Mini-version fits on the
smaller surface next to the
security compartment

Large version
also fits in the
security compartment

Order no.	148436-708	148436-709
Price	14,-	17,-



Additional binder supports

For insertion into the slotting
of the cabinet floor and the shelves

Height x depth	185 x 340
Order no.	148436-701
Price	15,-

Asisto

Mobile pedestals.

Features of the mobile pedestals:

- + Mobile pedestal with 4 casters, front casters with lock
- + Body and drawers made of steel
- + Central locking system with 2 flap keys and exchangeable cylinder
- + Drawers and interior fittings in black
- + User-friendly, full-width handle bar on the side
- + Optimum tilt resistance thanks to counterweight and drawer with anti-tilt mechanism
- + Long-lasting and durable steel drawers:
 - 3 HU on roller guide, with 4/5 pull-out
 - 6 HU on telescopic guide, with full extension slide
- + Horizontal partitions in the middle drawers



Order no. 054530-000-165



Order no. 054510-000-102



Order no. 054230-000-165



Order no. 054210-000-102

Dimensions and version

Width: 430

Height: 570

M = Material drawer

HU = Height units (1 HU = 50 mm)

Drawer 6 HU incl. add-on hanging frame



Depth	581	581	781	781
Drawers	M 3/6	M 3/3/3	M 3/6	M 3/3/3
Order no. RAL 9010 Pure white	054530-000-165	054510-000-165	054230-000-165	054210-000-165
Order no. RAL 9005 Deep black	054530-000-102	054510-000-102	054230-000-102	054210-000-102
Price	866,-	866,-	941,-	941,-

Only available in the following colors:



Pure white
RAL 9010
Color no. -165



Deep black
RAL 9005
Color no. -102



Company

Color concept

Changing room & wardrobe

Workshop & factory

Office & archive

Asisto

Fridge caddies and caddies with trash can.

The fridge caddies offer:

- + Excellent mobility thanks to 4 large casters (front casters with lock)
- + Steel body, double-walled, with body sound absorption for pleasant sound behavior
- + Drawers with load-bearing precision rails, all drawers fully extendable, with self-closing system and soft-stop for gentle closure
- + Drawers with versatile interior fittings
- + With cable flap above, 2 x power* connections (up to 230 V/50 Hz), e.g. for coffee maker etc., incl. 3 meter supply line
- + Refrigerator with lock (2 keys), 62 liter volume and 3 adjustable intermediate shelves (grates)

Models 54780-000 and 54780-150:

- + Drawer with cutlery compartment and small part drawer made of stainless steel
- + Drawer(s) with versatile configuration for cups and glasses
- + Drawer for storing plates and saucers



Order no. 54780-000

Dimensions and versions

Incl. HPL top and intermediate shelf, 13 mm thick

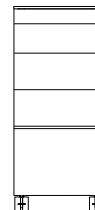
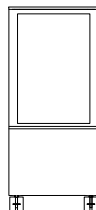
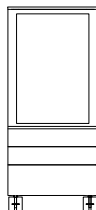

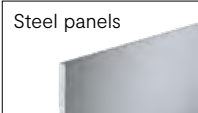
Cabinet height: 1,157 Cabinet width: 500 Cabinet depth: 600 	Drawers	2, 2, 2¾ HU	6¾ HU	2, 3, 4, 4, 6¾ HU
	Version	With refrigerator and 3 drawers incl. interior fittings for cutlery and dishes	With refrigerator and trash can 1x18 L, 2x8 L	Top drawer empty as standard, with trash can size 1x18 L, 2x8 L and drawers for dishes (interior fittings optional)
	Order no.	54780-000	54780-010	54780-150
	Price	2.781,-	2.781,-	2.982,-

*For socket strips to be used outside of Germany, please indicate the country of use (e.g. CH/Switzerland)

+ HPL top, large
 For the use of larger coffee makers, also with integrated cable flap above, 2x power connections (230 V)

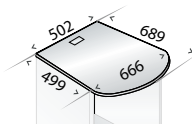

Width	502/666
Depth	499/689
& order no.	+ 5413-780
& addtl. charge	+ 85,-

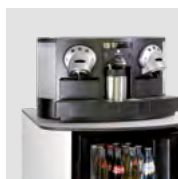

+ Automatic opening with motion sensor
 For caddy trash can, for hands-free opening, easy with a movement of the foot

For width	500
& order no.	+ 5400-760
& addtl. charge	+ 310,-



→ **Body color, panel/top decor and panel color**

Color concept → p. 50



Order no. 54780-010



Order no. 54780-150



All caddies with integrated HPL cable flap above, connection: 2x power (230 V)



Drawer with cutlery compartment and small part drawer made of stainless steel



Drawer(s) with versatile configuration for cups and glasses



Drawer for storing plates and saucers

