

MONTAGEANLEITUNG

Werkstatt-Schränke mit Sichtlagerkästen

Serie 13.. + Serie 89..

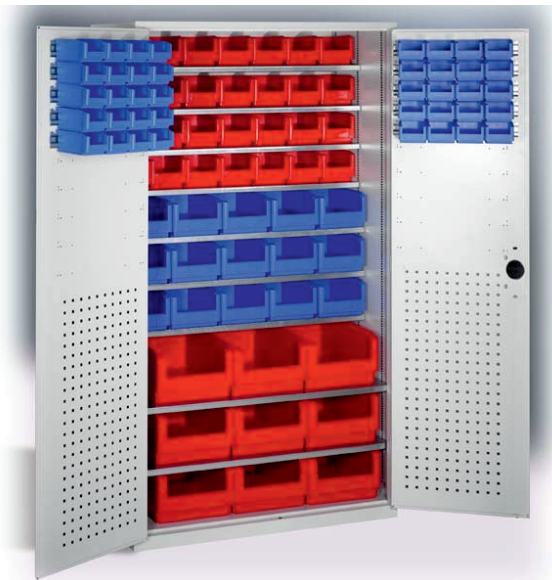

C+P Möbelsysteme GmbH & Co. KG
Boxbachstraße 1
D-35236 Breidenbach (Germany)
www.cp.de



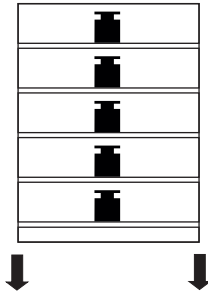
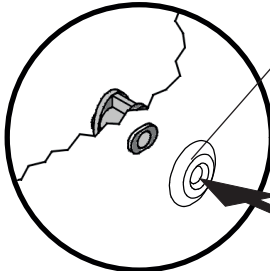
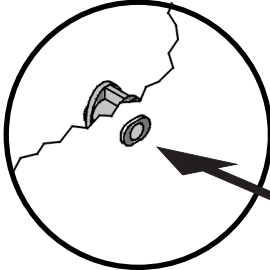
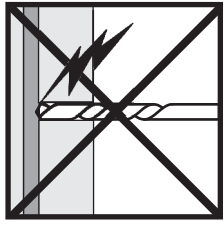
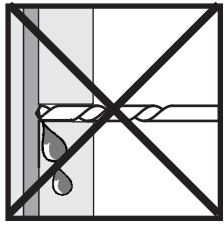
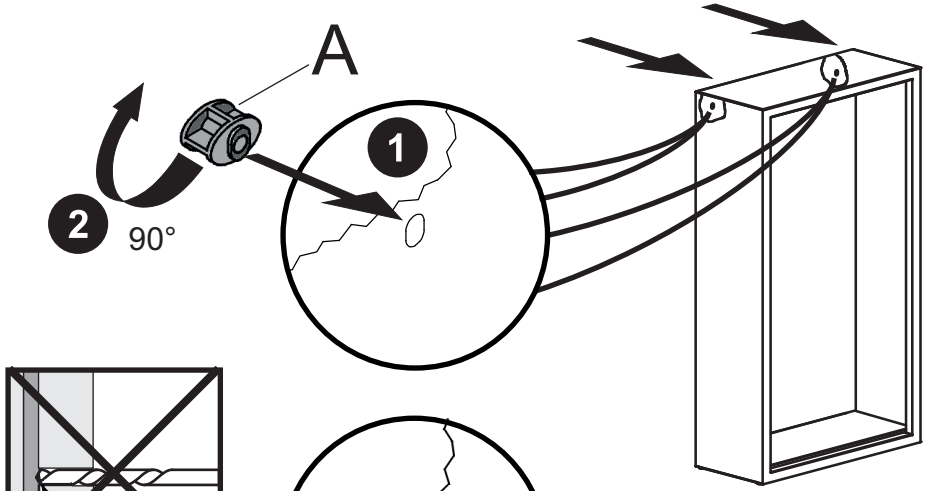
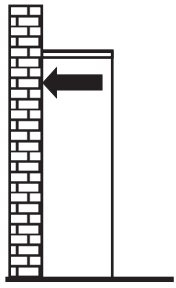
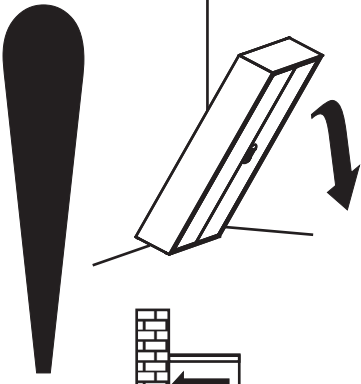
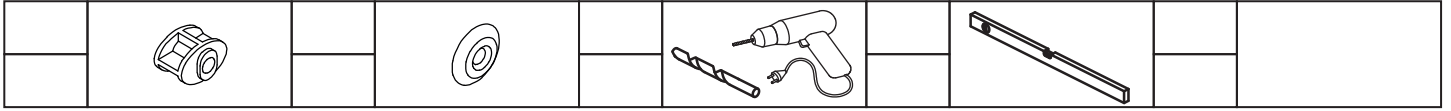

$\Sigma = 450 \text{ kg}$

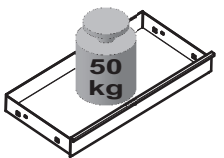
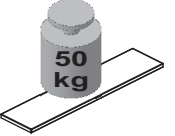
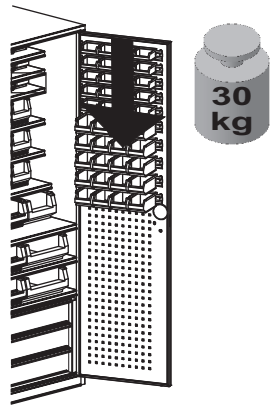
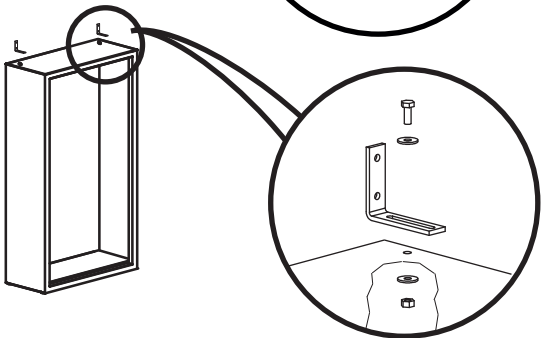
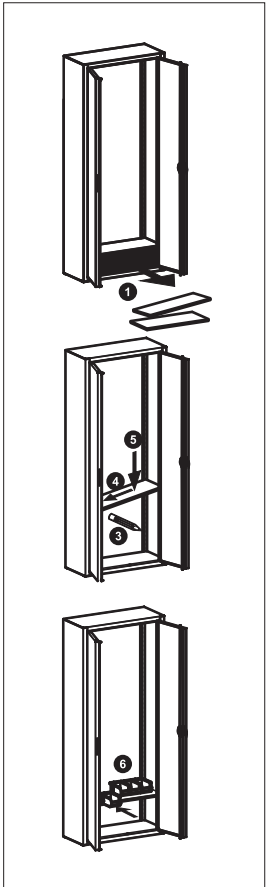

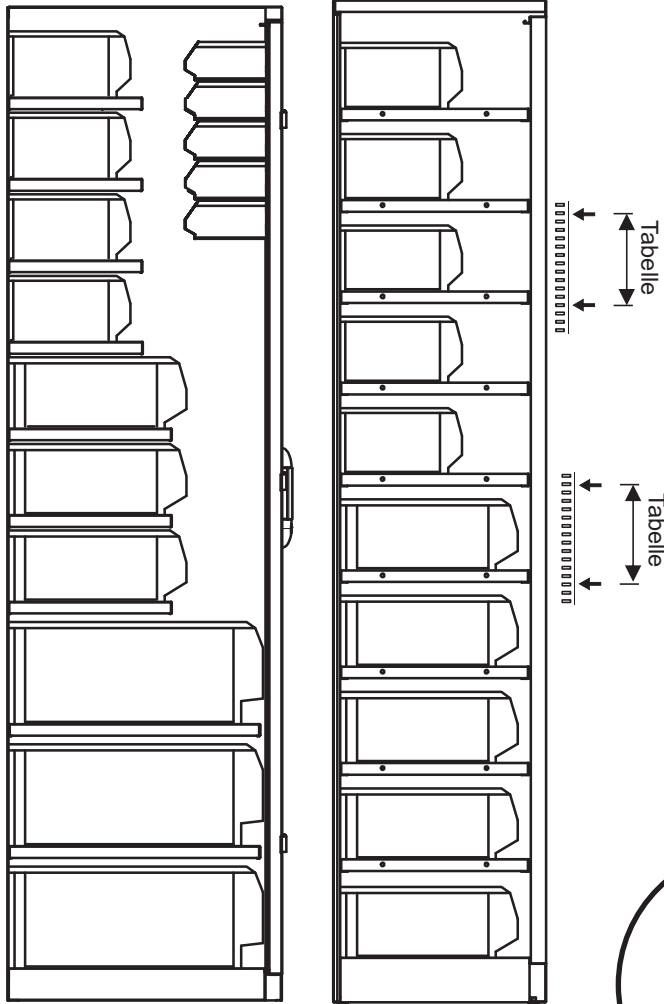
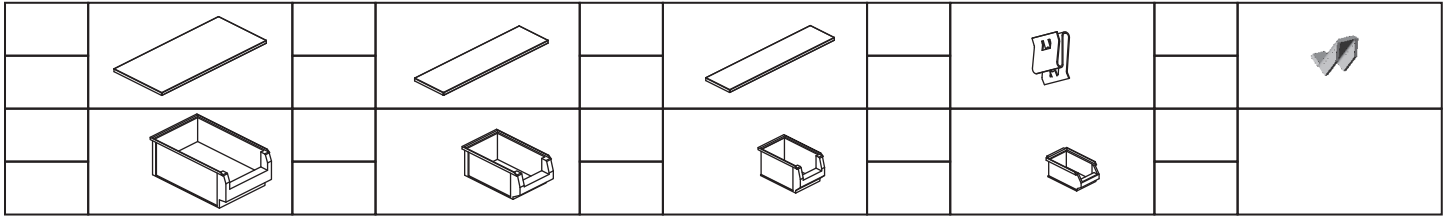

Beispiel-Bestückung

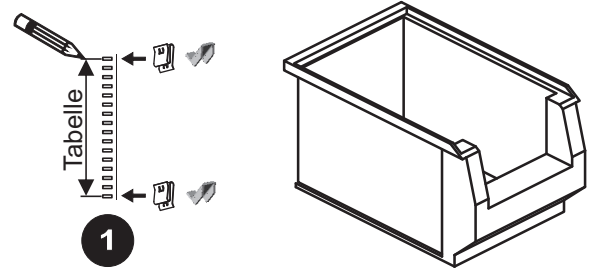

Nr.	Höhe	Breite	Tiefe	Maße in mm	
				Abstand	
1	50	102	85	60	1
2	75	103	160	90	
3	125	150	230	140	
RK 3214	145	210	350	180	
RK 3209				130	
RK 3109				130	
4	145	210	350	160	
5	200	210	350	220	
6	145	315	500	170	
7	200	315	500	240	

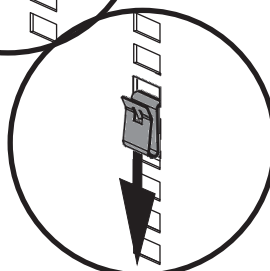
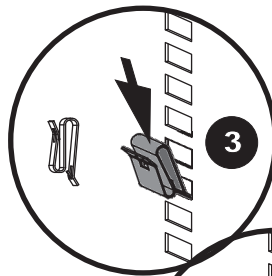
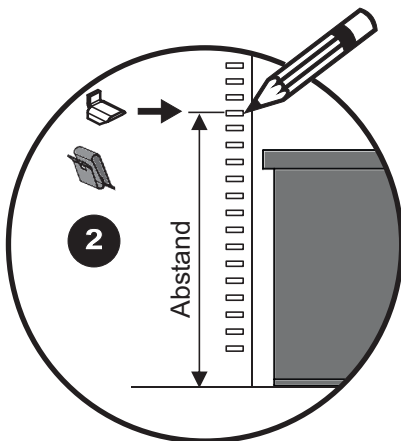
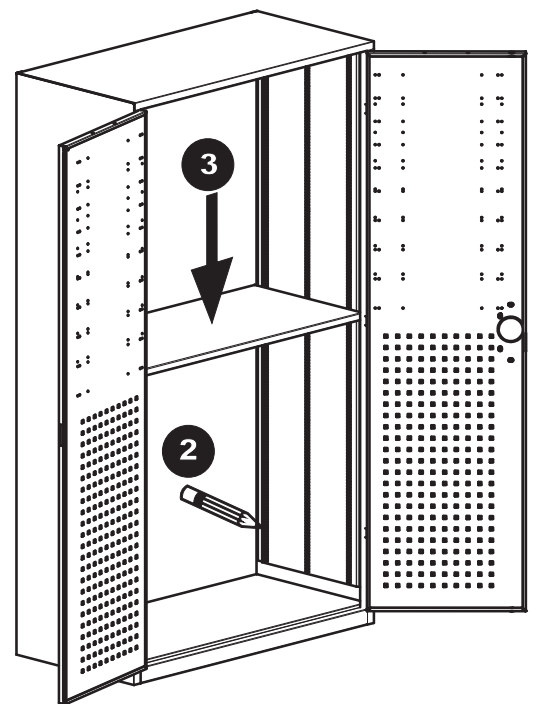
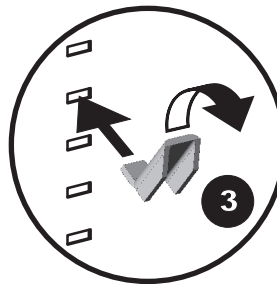

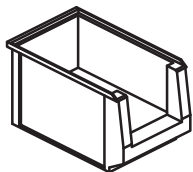

	1		2		3		4		5		6		7	
	ROT	BLAU	ROT	BLAU	ROT	BLAU	ROT	BLAU	ROT	BLAU	ROT	BLAU	ROT	BLAU
130276-61	40			80	28			20						
130276-613														
130276-62	40			90	28			15						
130276-63	40			70	21			15						
130276-64	40			70	21			5			6			
130276-65				40	28			15					9	
130276-66				56		35					6		9	
130276-67				40	28			15						
130276-68				56	35						6			
133113-21					24	24								
133113-22						24	60							
133113-23							54	60						
133144-22			12											
133144-24			40											
133144-25					30					15				
133144-27					30			20						
133144-28														
133144-29							12	12						
133413-03						24	36							
133413-20														
133413-210														
133413-22					20	20								
133413-23						24	36							
133413-24	45	45	24	24										
133413-25							24	48						
133413-27	18	18	18			20								
133413-29			48	48										
134013-21								42						
134013-22														
134013-23			18	12										
134013-24			24			8								
8931-501	40	40	44	44	7			5						
8931-502	40	40			28	21	5	10						

Sichtlagerkästen

lose, inkl. Etiketten

1. Maße

Größe	1	2	3	4	5	6	7
Außenmaße H x B x T	50 x 102 x 85	75 x 103 x 160	125 x 150 x 230	145 x 210 x 350	200 x 210 x 350	145 x 315 x 500	200 x 315 x 500
Verpackungseinheit	60 Stk.	40 Stk.	20 Stk.	10 Stk.	10 Stk.	8 Stk.	6 Stk.



Farbe rot

Bestell-Nr. **8920-59153** **8920-59253** **8920-59353** **8920-59453** **8920-59553** **8920-59653** **8920-59753**

Preis € 79,- 119,- 159,- 199,- 129,- 179,- 159,-



Farbe blau

Bestell-Nr. **8920-59155** **8920-59255** **8920-59355** **8920-59455** **8920-59555** **8920-59655** **8920-59755**

Preis € 99,- 139,- 179,- 199,- 189,- 199,- 199,-